

# HA1630D04/05/06 Series

## Ultra-Small Low Voltage Operation CMOS Dual Operational Amplifier

REJ03D0801-0200

Rev.2.00

Feb 07, 2007

### Description

The HA1630D04/05/06 are high slew rate dual CMOS Operational Amplifiers realizing low voltage operation, low input offset voltage and low supply current. In addition to a low operating voltage from 1.8V, these device output can achieve full swing output voltage capability extending to either supply. Available in an ultra-small TSSOP-8 and MMPAK-8 package that occupy more small area against the SOP-8.

### Features

- Low power and single supply operation  $V_{DD} = 1.8$  to  $5.5$  V
- Low input offset voltage  $V_{IO} = 4.0$  mV Max
- Low supply current (per channel)  $I_{DD} = 200$   $\mu$ A Typ (HA1630D04)  
 $I_{DD} = 400$   $\mu$ A Typ (HA1630D05)  
 $I_{DD} = 800$   $\mu$ A Typ (HA1630D06)
- High slew rate  $SR = 2$  V/ $\mu$ s Typ (HA1630D04)  
 $SR = 4$  V/ $\mu$ s Typ (HA1630D05)  
 $SR = 8$  V/ $\mu$ s Typ (HA1630D06)
- Maximum output voltage  $V_{OH} = 2.9$  V Min (at  $V_{DD} = 3.0$  V)
- Low input bias current  $I_{IB} = 1$  pA Typ

### Ordering Information

Type No.	Package Name	Package Code
HA1630D04T	TTP-8DA	PTSP0008JC-B
HA1630D05T		
HA1630D06T		
HA1630D04MM	MMPAK-8	PLSP0008JC-A
HA1630D05MM		
HA1630D06MM		

## Pin Arrangement

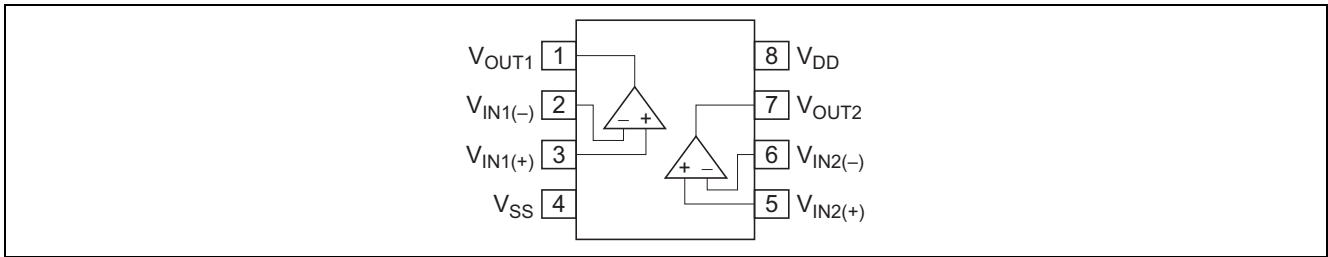

## Equivalent Circuit (per one channel)

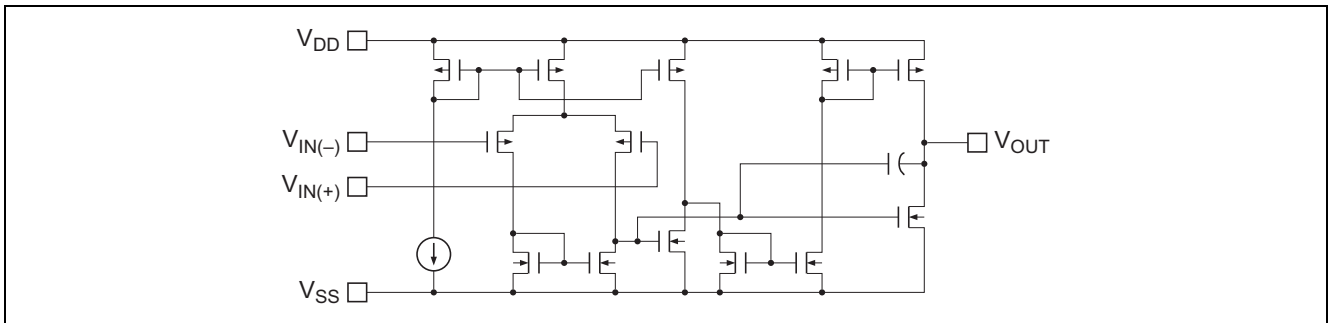

## Absolute Maximum Ratings

(Ta = 25°C)

Items	Symbol	Ratings	Unit	Note
Supply voltage	V <sub>DD</sub>	7	V	
Differential input voltage	V <sub>IN(diff)</sub>	-V <sub>DD</sub> to +V <sub>DD</sub>	V	
Input voltage	V <sub>IN</sub>	-0.3 to +V <sub>DD</sub>	V	*1
Power dissipation	P <sub>T</sub>	240/145	mW	TTP-8DA/MMPAK-8 *2
Operating temp. Range	Topr	-40 to +85	°C	
Storage temp. Range	Tstg	-55 to +125	°C	

Notes: 1. Do not apply Input Voltage exceeding V<sub>DD</sub> or 7 V.2. The value of PTSP0008JC-B (TTP-8DAV) / PLSP0008JC-A (MMPAK-8). It computes from heat resistance  $\theta_{ja} = 520^{\circ}\text{C}/\text{W}$ , and  $690^{\circ}\text{C}/\text{W}$  each other.

## Electrical Characteristics

(V<sub>DD</sub> = 3.0 V, Ta = 25°C)

Items	Symbol	Min	Typ	Max	Unit	Test Condition
Input offset voltage	V <sub>IO</sub>	—	—	4.0	mV	V <sub>in</sub> = 1.5 V
Input offset current	I <sub>IO</sub>	—	(1.0)	—	pA	V <sub>in</sub> = 1.5 V
Input bias current	I <sub>IB</sub>	—	(1.0)	—	pA	V <sub>in</sub> = 1.5 V
Output high voltage	V <sub>OH</sub>	2.9	—	—	V	R <sub>L</sub> = 100 k $\Omega$
Output source current	I <sub>O SOURCE</sub>	100	200	—	$\mu\text{A}$	V <sub>OH</sub> = 2.5 V (HA1630D04)
		200	400	—		V <sub>OH</sub> = 2.5 V (HA1630D05)
		400	800	—		V <sub>OH</sub> = 2.5 V (HA1630D06)
Output low voltage	V <sub>OL</sub>	—	—	0.1	V	R <sub>L</sub> = 100 k $\Omega$
Output sink current	I <sub>O SINK</sub>	—	(5.0)	—	mA	V <sub>OL</sub> = 0.5 V (HA1630D04)
		—	(6.0)	—		V <sub>OL</sub> = 0.5 V (HA1630D05)
		—	(6.5)	—		V <sub>OL</sub> = 0.5 V (HA1630D06)
Common mode input voltage range	V <sub>CM</sub>	-0.05 to 2.1	—	—	V	(HA1630D04, HA1630D05)
		0 to 1.9	—	—		(HA1630D06)
Slew rate	SR	—	(2.0)	—	V/ $\mu\text{s}$	C <sub>L</sub> = 20 pF (HA1630D04)
		—	(4.0)	—		C <sub>L</sub> = 20 pF (HA1630D05)
		—	(8.0)	—		C <sub>L</sub> = 20 pF (HA1630D06)
Voltage gain	A <sub>V</sub>	60	90	—	dB	
Gain bandwidth product	BW	—	(2100)	—	kHz	C <sub>L</sub> = 20 pF (HA1630D04)
		—	(3300)	—		C <sub>L</sub> = 20 pF (HA1630D05)
		—	(3600)	—		C <sub>L</sub> = 20 pF (HA1630D06)
Power supply rejection ratio	PSRR	50	70	—	dB	
Common mode rejection ratio	CMRR	50	70	—	dB	
Supply current	I <sub>DD</sub>	—	400	800	$\mu\text{A}$	R <sub>L</sub> = $\infty$ (HA1630D04)
		—	800	1600		R <sub>L</sub> = $\infty$ (HA1630D05)
		—	1600	3400		R <sub>L</sub> = $\infty$ (HA1630D06)

Notes: 1. In the case of continuous current flow, use a sink current of under 4 mA.

2. ( ) : Design specification

Table of Graphs

Electrical Characteristics			HA1630D04 Figure	HA1630D05 Figure	HA1630D06 Figure	Test Circuit
Supply current	$I_{DD}$	vs Supply voltage	1-1	2-1	3-1	2
		vs Ambient temperature	1-2	2-2	3-2	
Output high voltage	$V_{OH}$	vs Output source current	1-3	2-3	3-3	4
		vs Supply voltage	1-4	2-4	3-4	
Output source current	$I_{O\ SOURCE}$	vs Ambient temperature	1-5	2-5	3-5	6
Output low voltage	$V_{OL}$	vs Output sink current	1-6	2-6	3-6	5
Output sink current	$I_{O\ SINK}$	vs Ambient temperature	1-7	2-7	3-7	6
Input offset voltage	$V_{IO}$	Distribution	1-8	2-8	3-8	1
		vs Supply voltage	1-9	2-9	3-9	
		vs Ambient temperature	1-10	2-10	3-10	
Common mode input voltage range	$V_{CM}$	vs Ambient temperature	1-11	2-11	3-11	7
Power supply rejection ratio	PSRR	vs Frequency	1-12	2-12	3-12	1
Common mode rejection ratio	CMRR	vs Frequency	1-13	2-13	3-13	7
Voltage gain & phase angle	$A_V$	vs Frequency	1-14	2-14	3-14	10
Input bias current	$I_{IB}$	vs Ambient temperature	1-15	2-15	3-15	3
		vs Input voltage	1-16	2-16	3-16	
Slew Rate (rising)	SRr	vs Ambient temperature	1-17	2-17	3-17	9
Slew Rate (falling)	SRf	vs Ambient temperature	1-18	2-18	3-18	
Slew rate		Large signal transient response	1-19	2-19	3-19	
		Small signal transient response	1-20	2-20	3-20	
Total harmonic distortion + noise	(0 dB)	vs. Output voltage p-p	1-21	2-21	3-21	8
	(40 dB)	vs. Output voltage p-p	1-22	2-22	3-22	
Maximum p-p output voltage		vs Frequency	1-23	2-23	3-23	
Voltage noise density		vs Frequency	1-24	2-24	3-24	
Channel separation		vs Frequency	1-25	2-25	3-25	

Main Characteristics (HA1630D04)

Figure 1-1. HA1630D04  
Supply Current vs. Supply Voltage

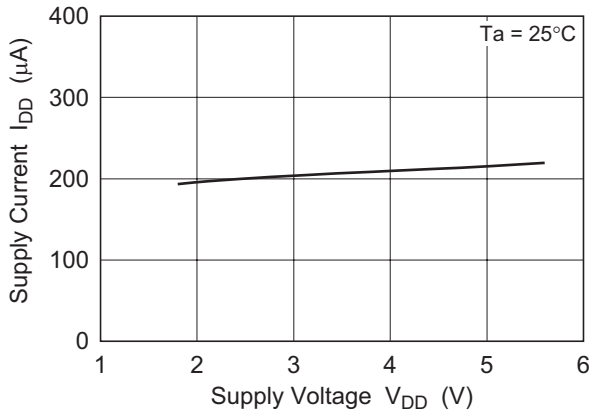

Figure 1-2. HA1630D04  
Supply Current vs. Ambient Temperature

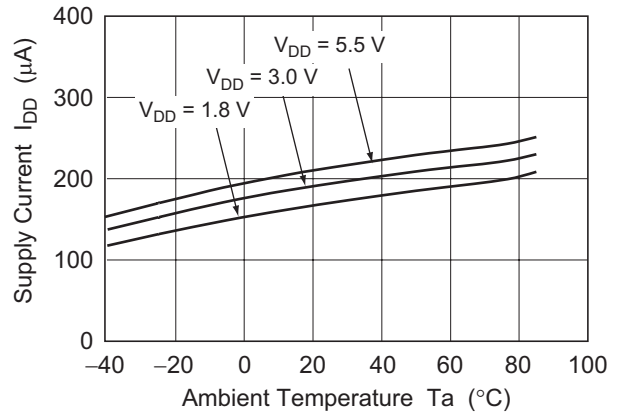

Figure 1-3. HA1630D04  
Output High Voltage vs. Output Source Current

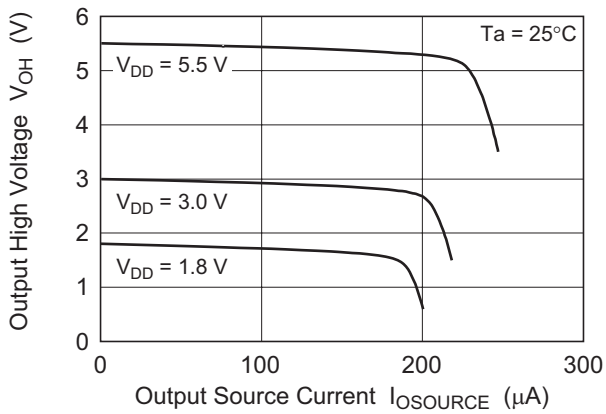

Figure 1-4. HA1630D04  
Output High Voltage vs. Supply Voltage

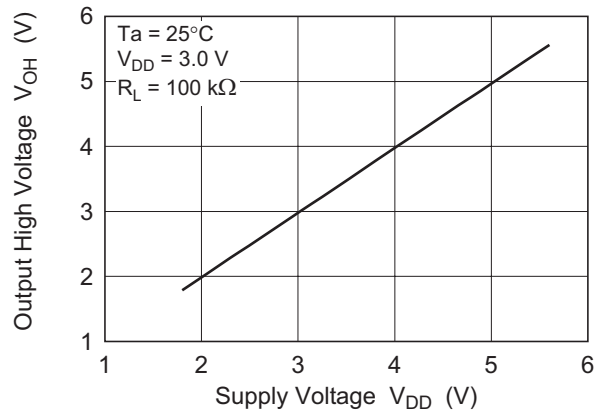
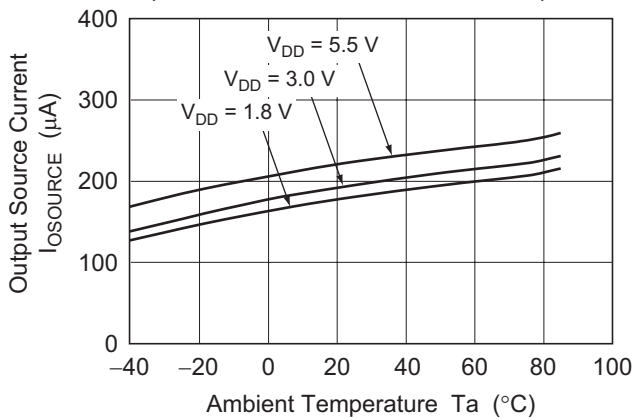

Figure 1-5. HA1630D04  
Output Source Current vs. Ambient Temperature



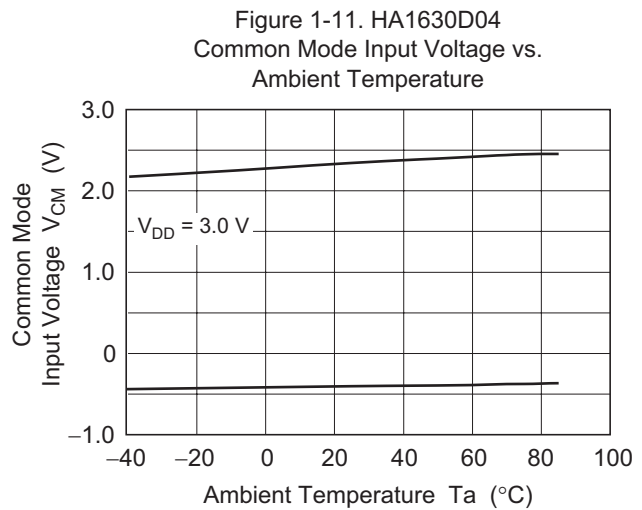
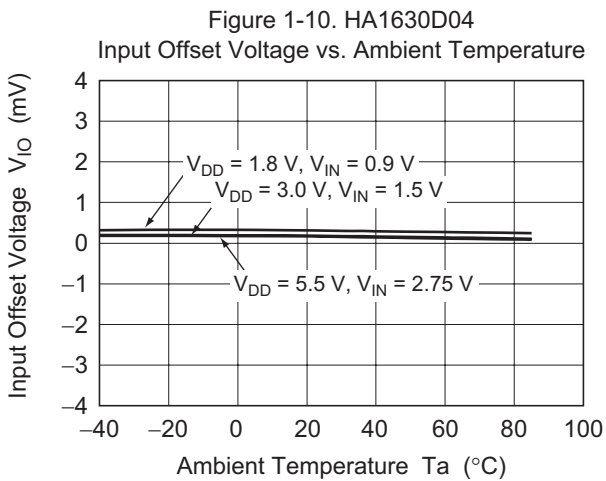
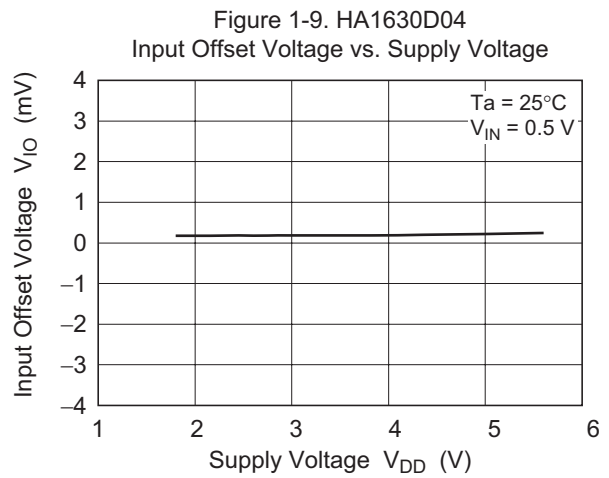
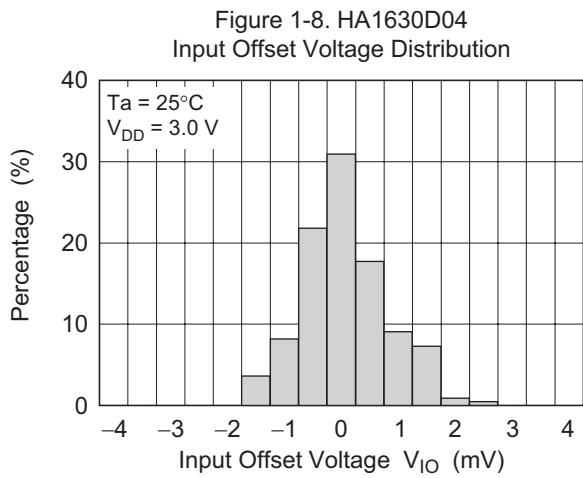
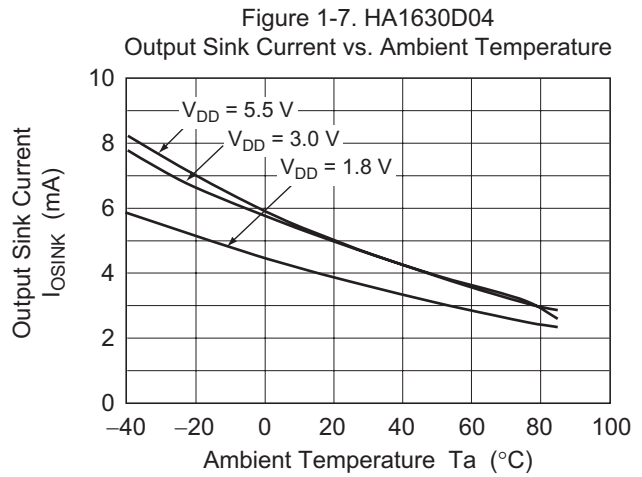
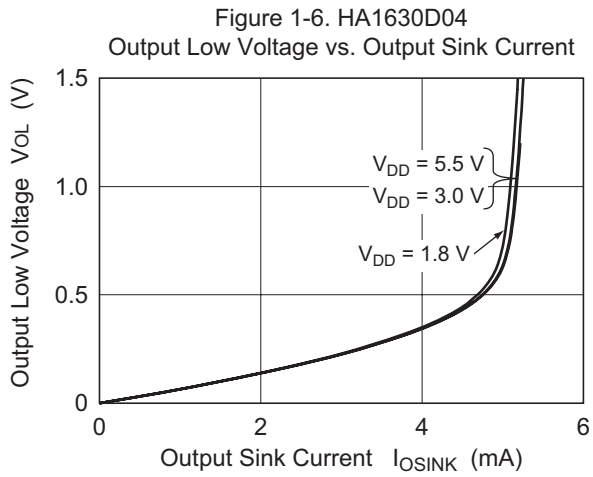

Figure 1-12. HA1630D04  
Power Supply Rejection Ratio vs. Frequency

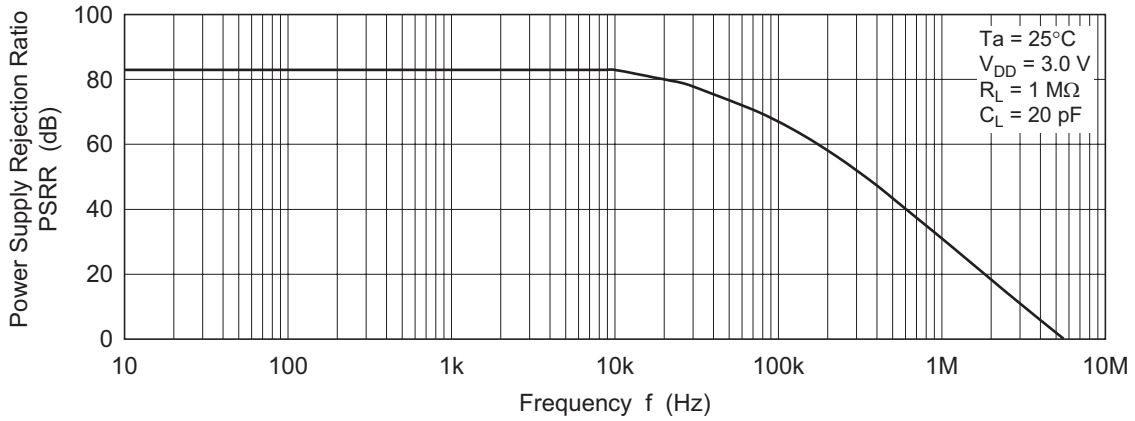

Figure 1-13. HA1630D04  
Common Mode Rejection Ratio vs. Frequency

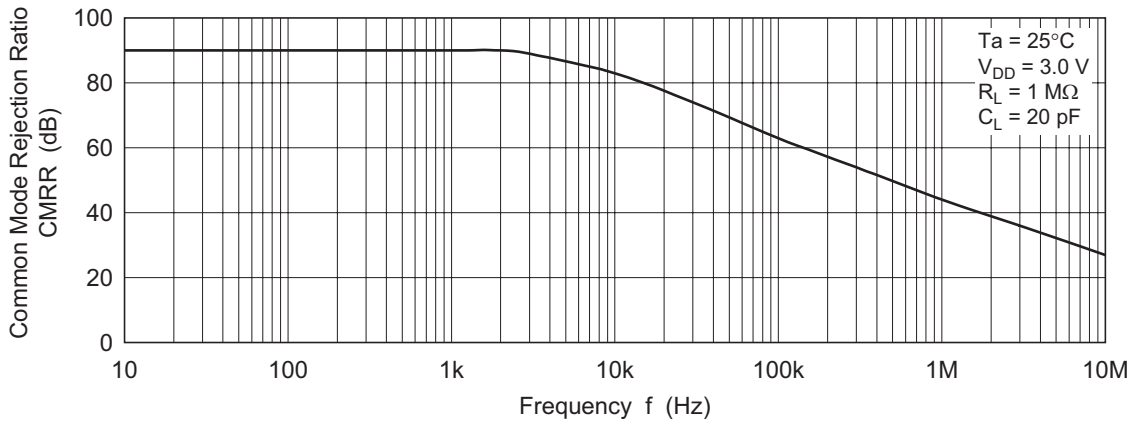
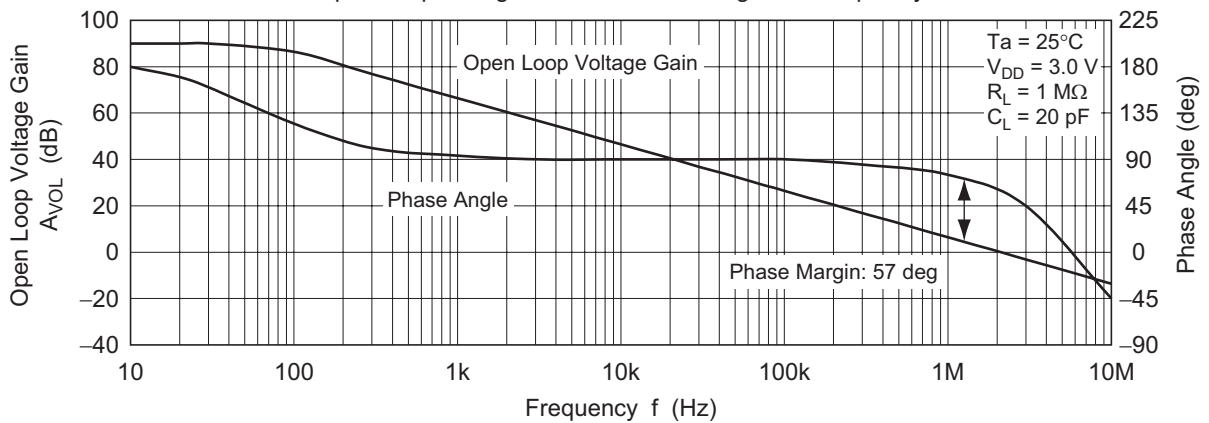

Figure 1-14. HA1630D04  
Open Loop Voltage Gain and Phase Angle vs. Frequency



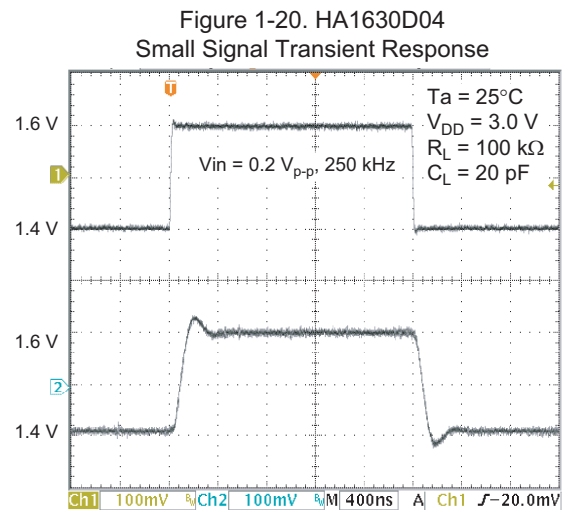
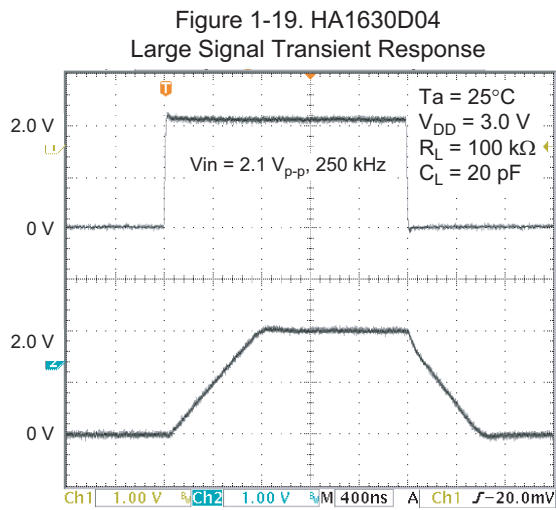
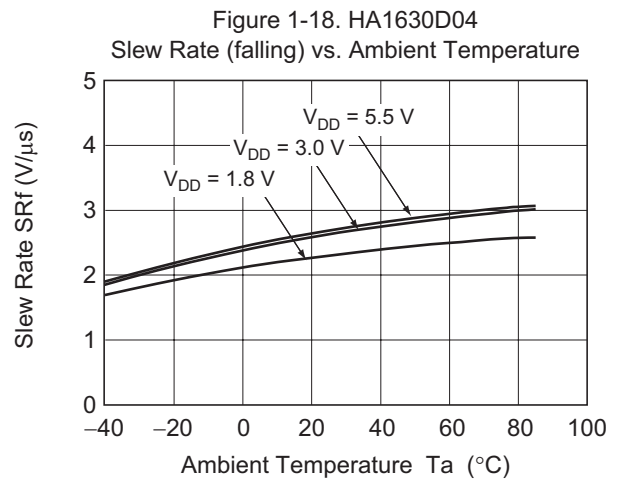
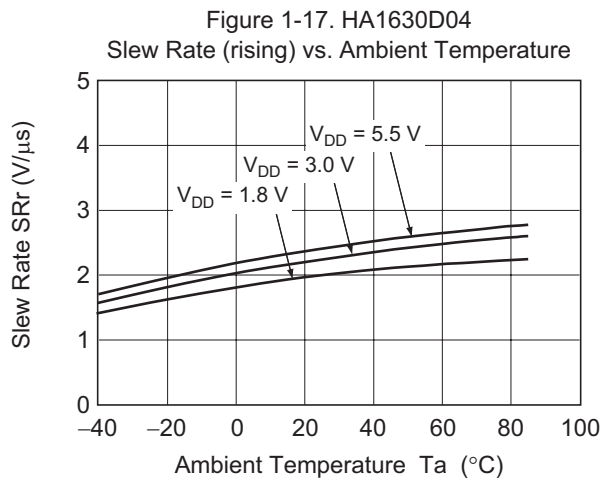
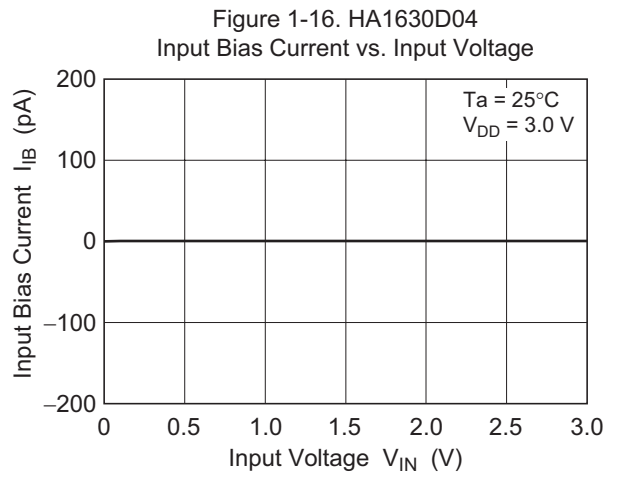
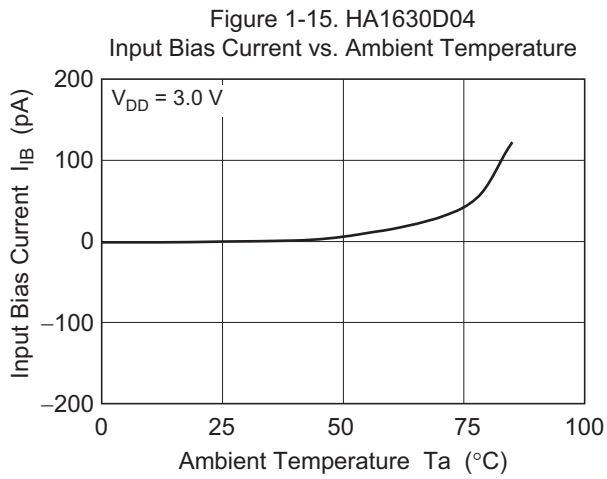



Figure 1-21. HA1630D04  
Total Harmonic Distortion + Noise vs.  
Output Voltage p-p

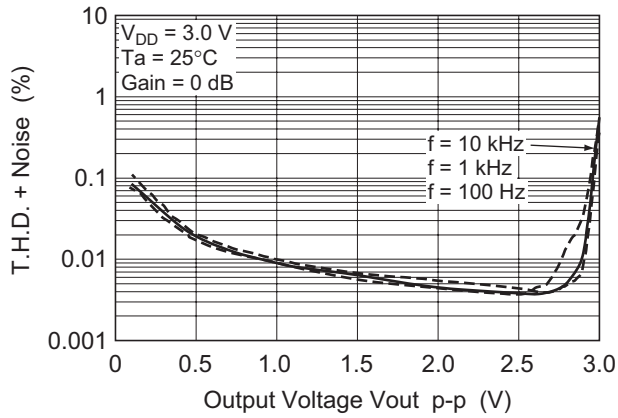

Figure 1-22. HA1630D04  
Total Harmonic Distortion + Noise vs.  
Output Voltage p-p

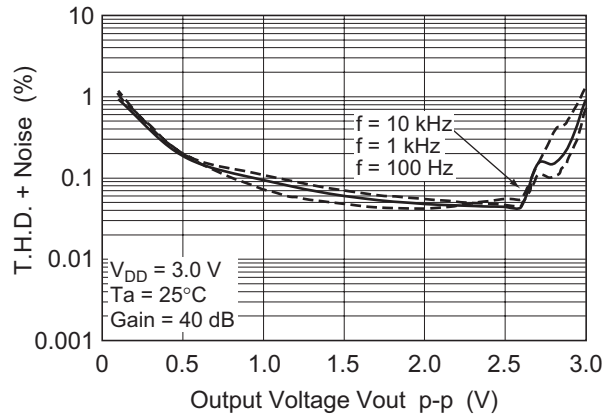

Figure 1-23. HA1630D04  
Voltage Output p-p vs. Frequency

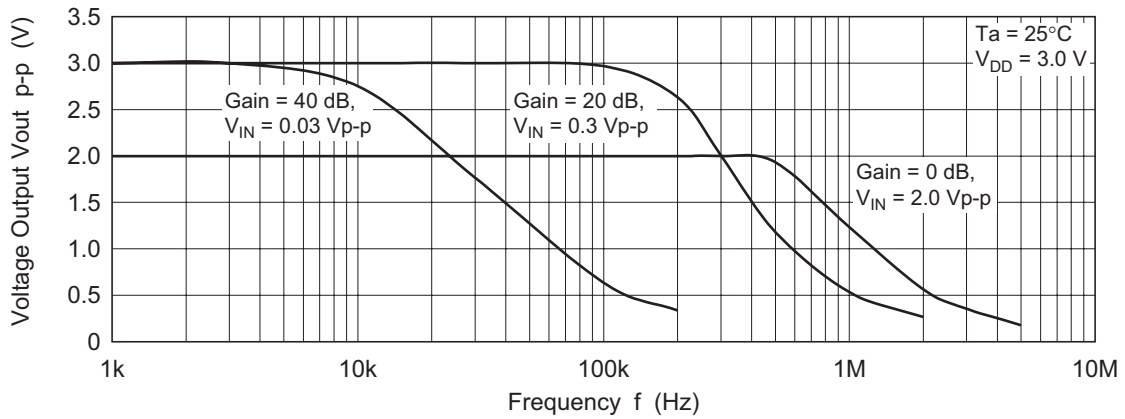

Figure 1-24. HA1630D04  
Voltage Noise Density vs. Frequency

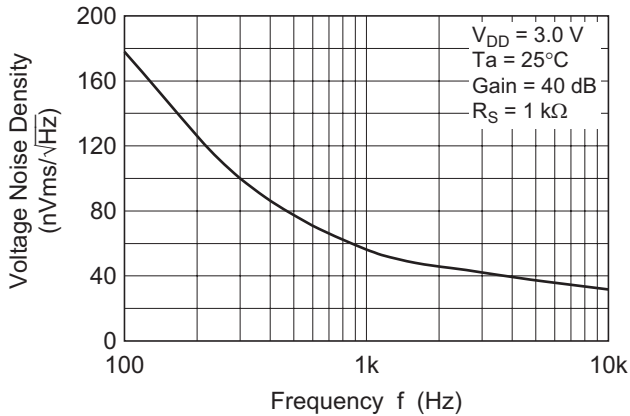
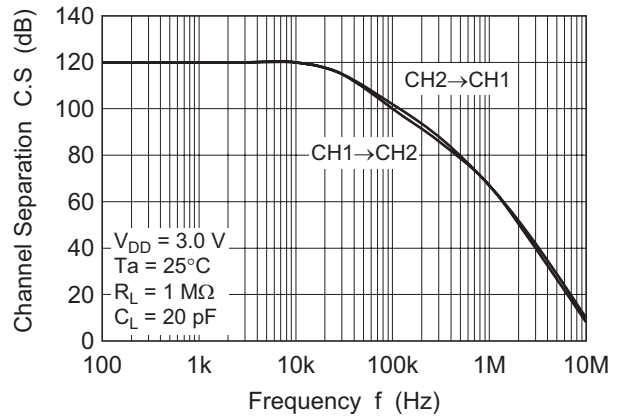
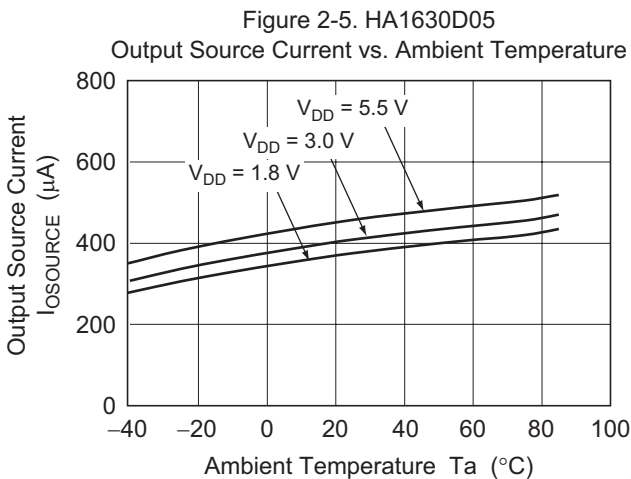
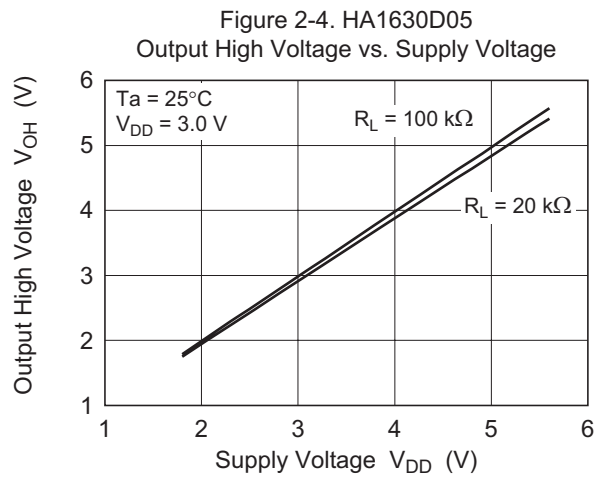
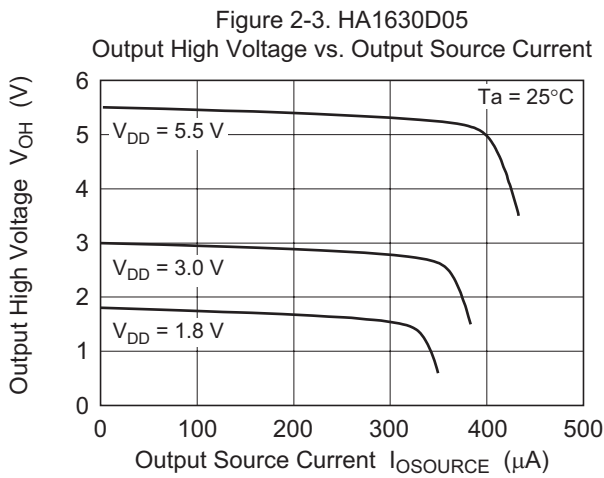
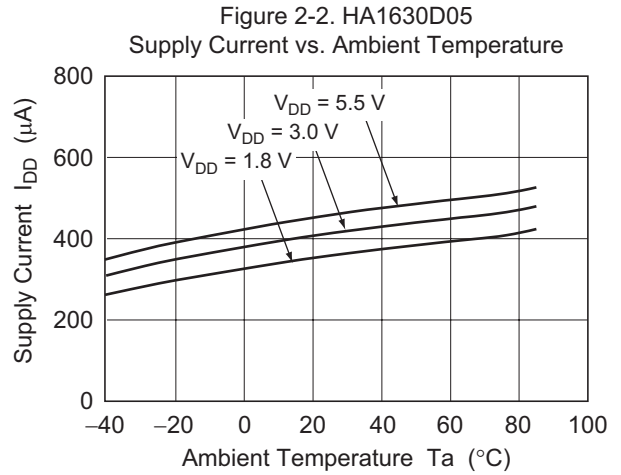
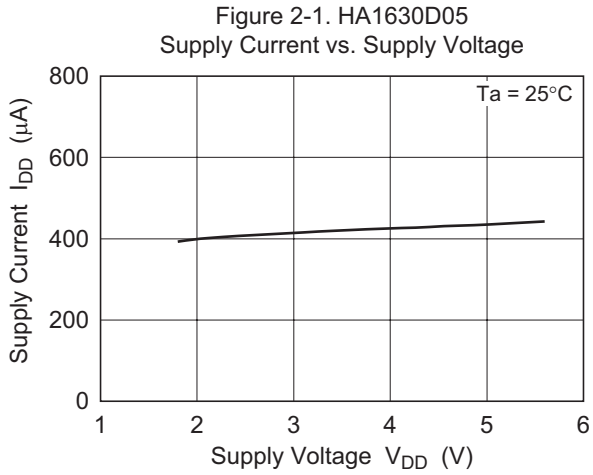

Figure 1-25. HA1630D04  
Channel Separation vs. Frequency



Main Characteristics (HA1630D05)



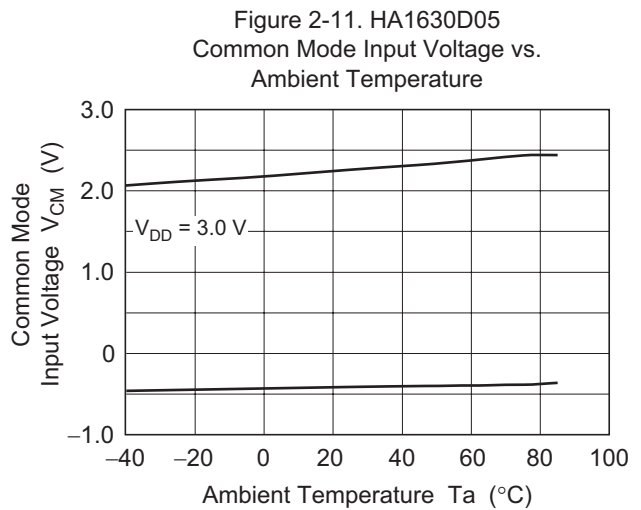
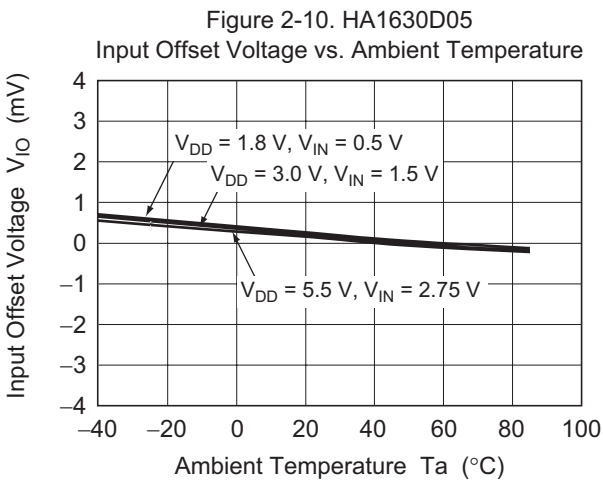
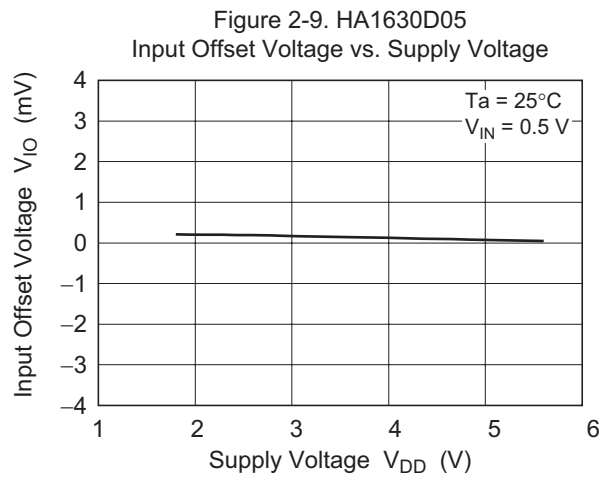
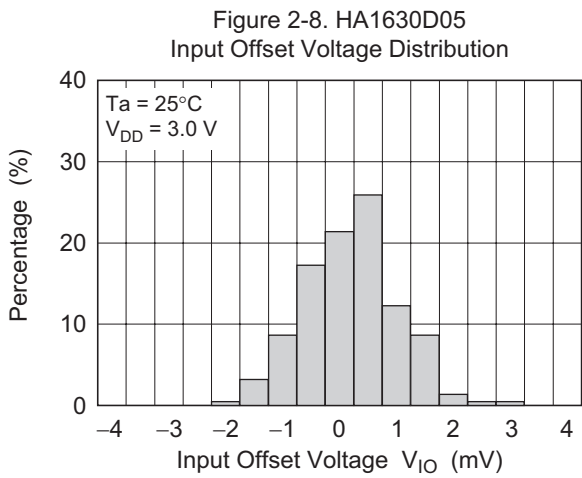
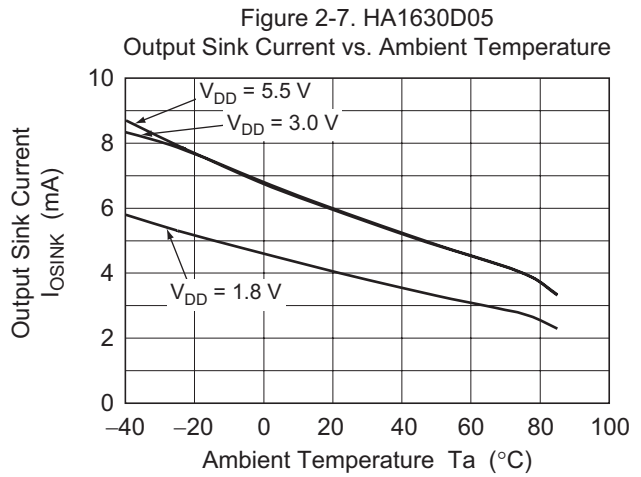
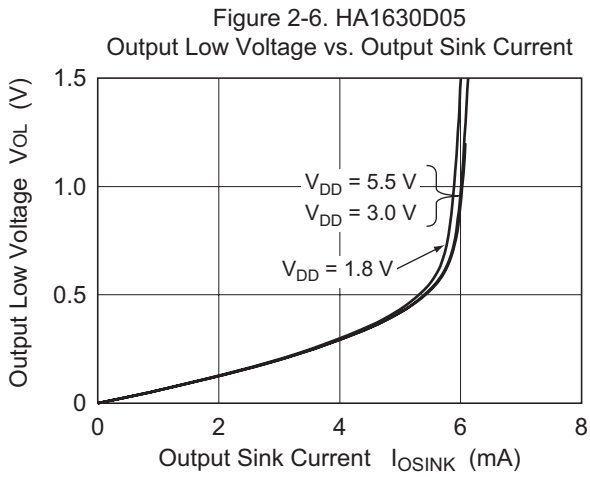

Figure 2-12. HA1630D05  
Power Supply Rejection Ratio vs. Frequency

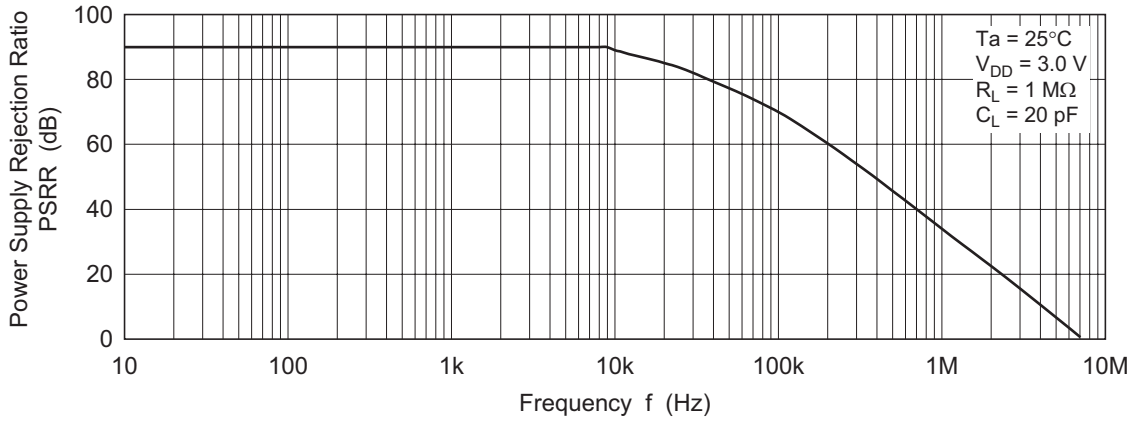

Figure 2-13. HA1630D05  
Common Mode Rejection Ratio vs. Frequency

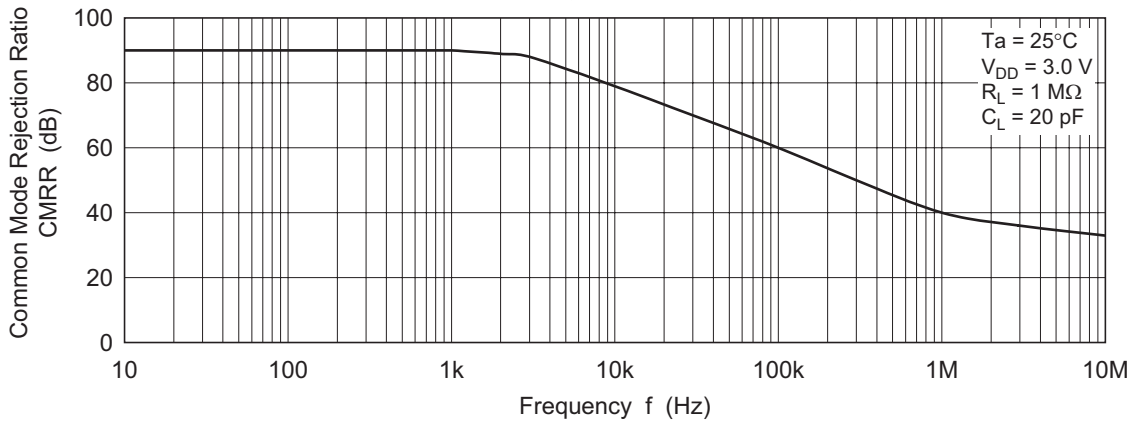
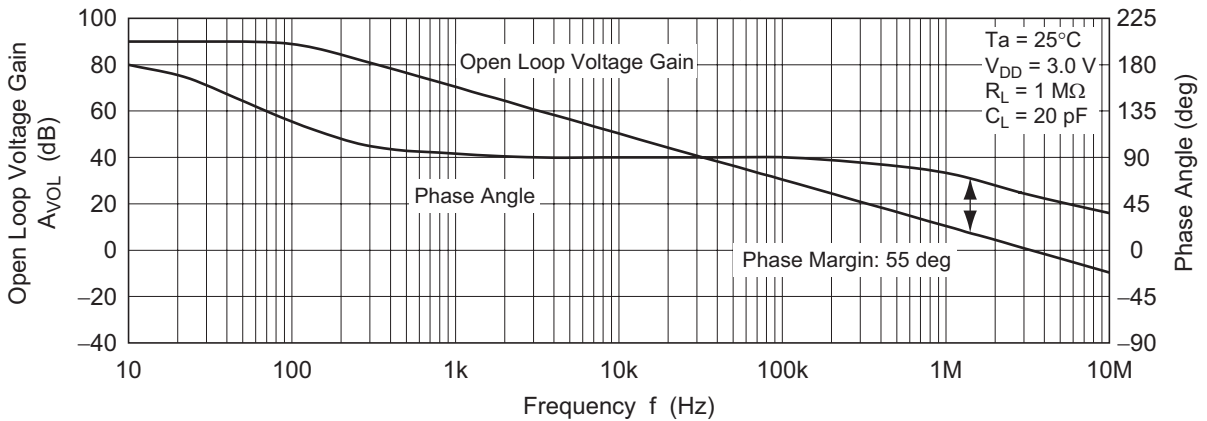

Figure 2-14. HA1630D05  
Open Loop Voltage Gain and Phase Angle vs. Frequency



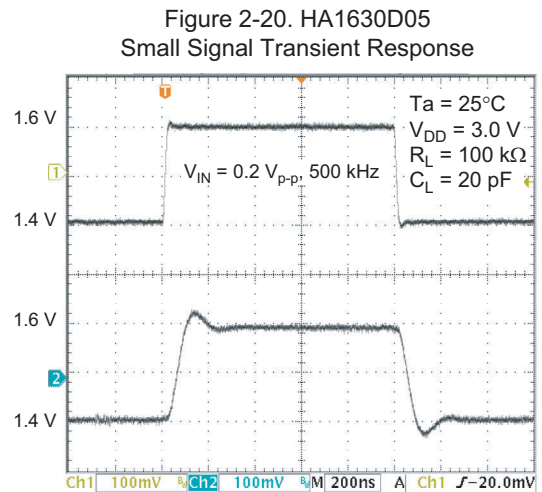
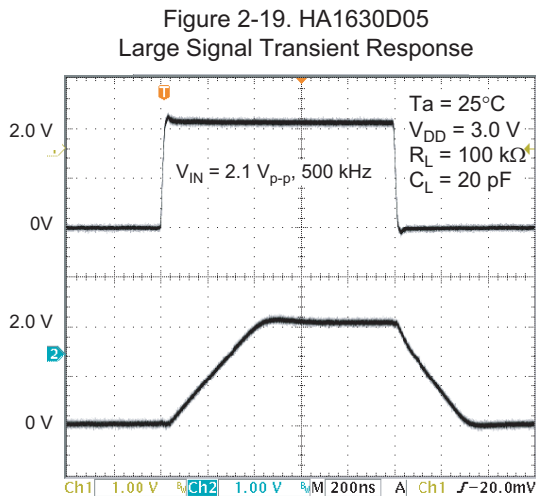
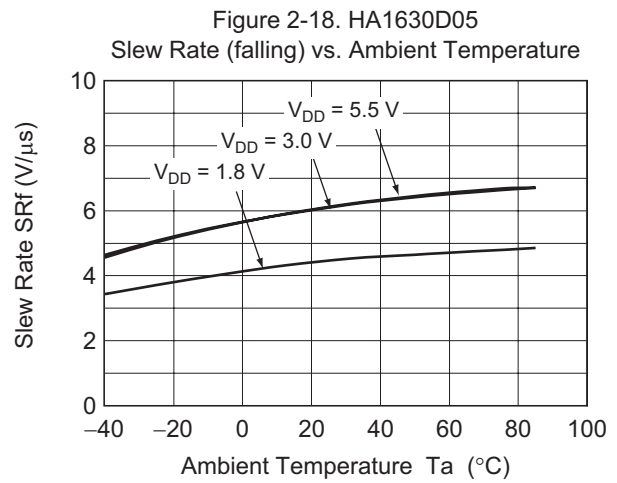
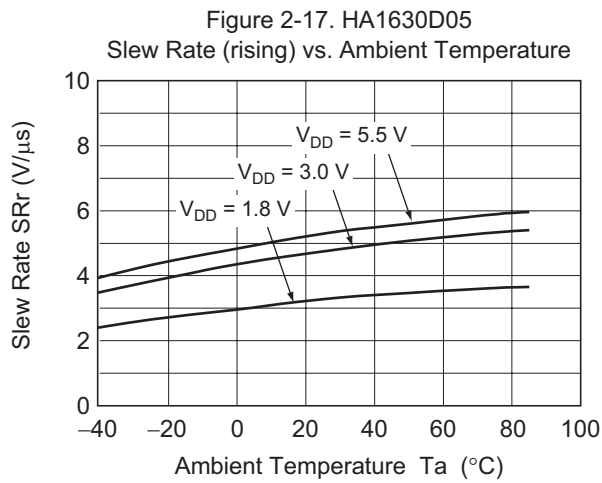
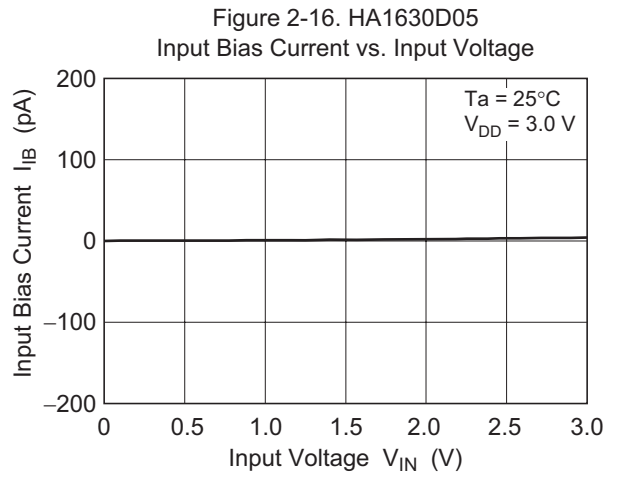
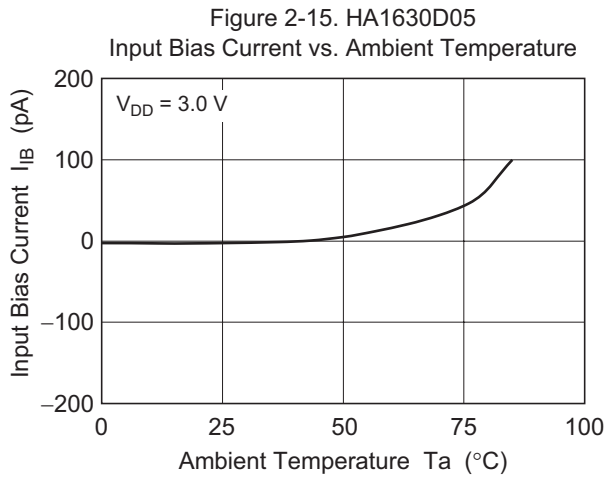

Figure 2-21. HA1630D05  
Total Harmonic Distortion + Noise vs.  
Output Voltage p-p

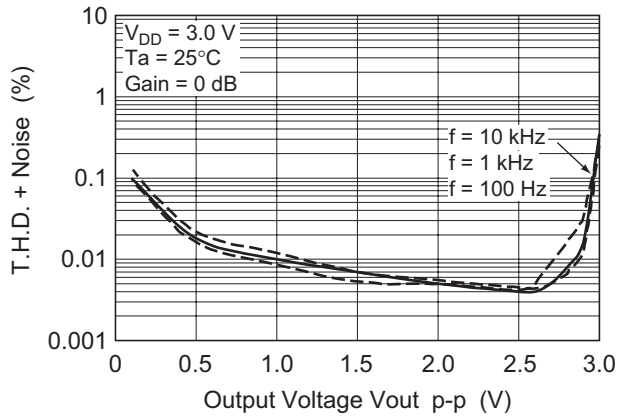

Figure 2-22. HA1630D05  
Total Harmonic Distortion + Noise vs.  
Output Voltage p-p

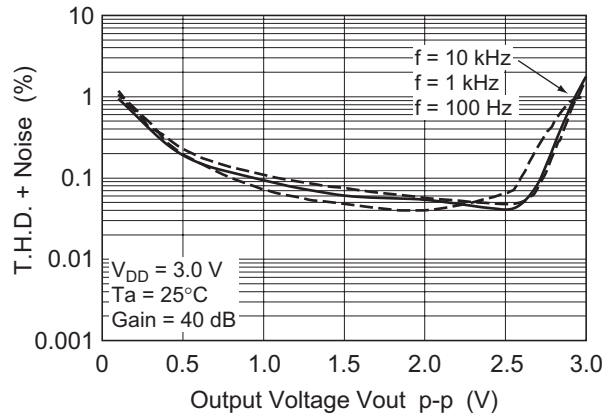

Figure 2-23. HA1630D05  
Voltage Output p-p vs. Frequency

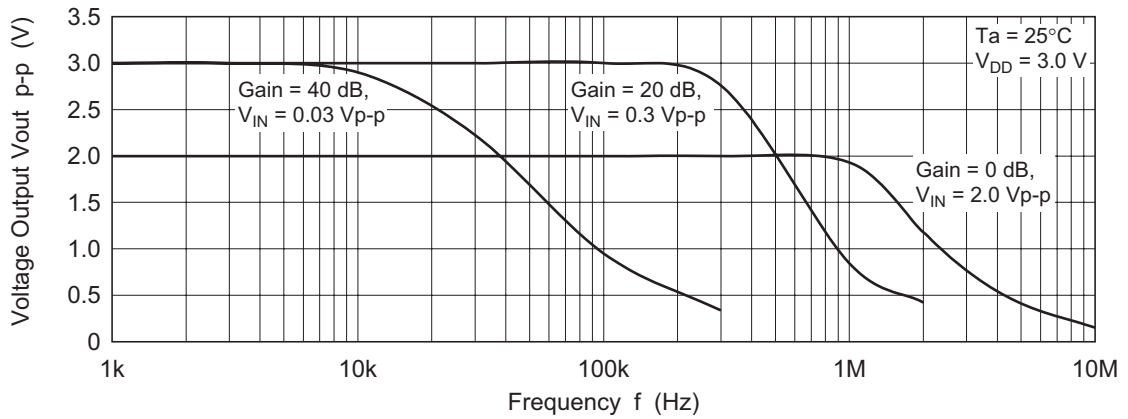

Figure 2-24. HA1630D05  
Voltage Noise Density vs. Frequency

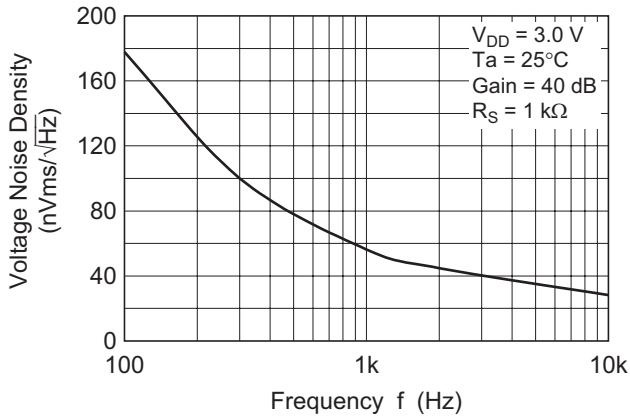
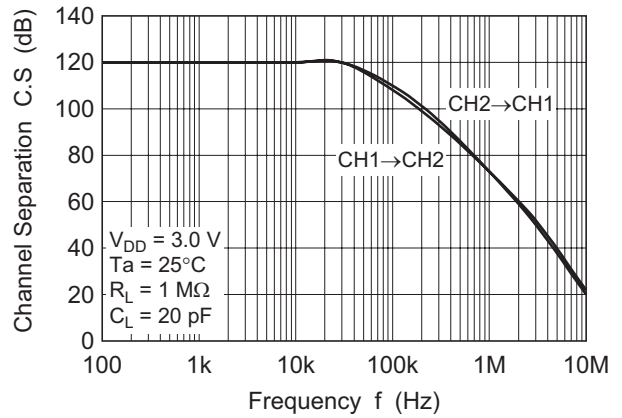
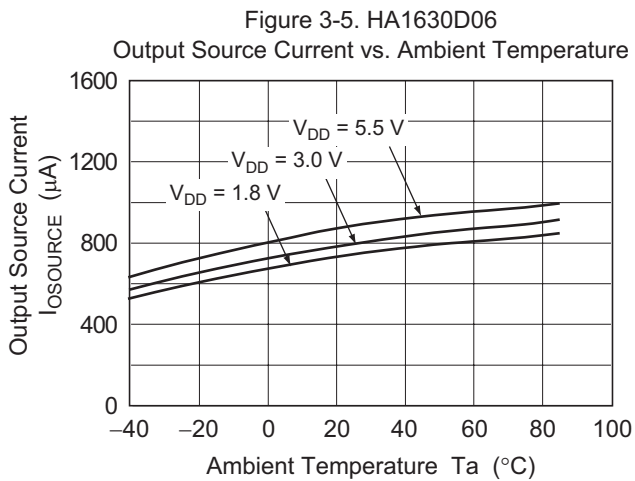
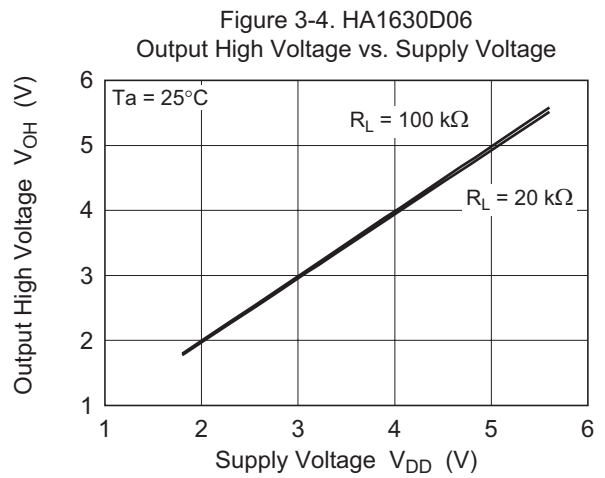
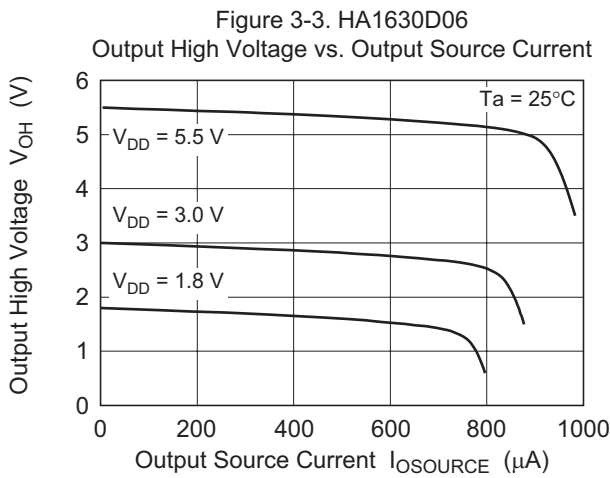
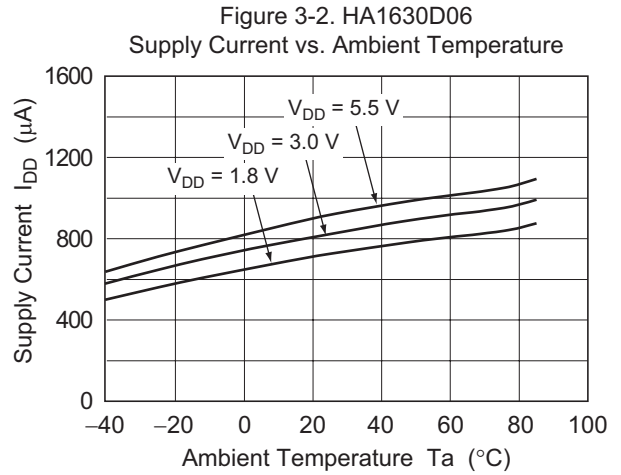
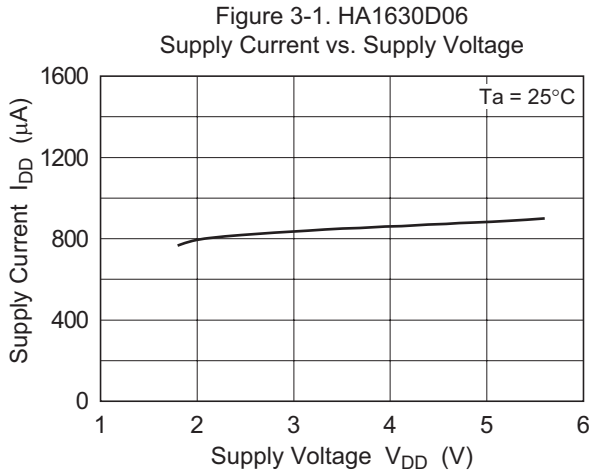

Figure 2-25. HA1630D05  
Channel Separation vs. Frequency



Main Characteristics (HA1630D06)



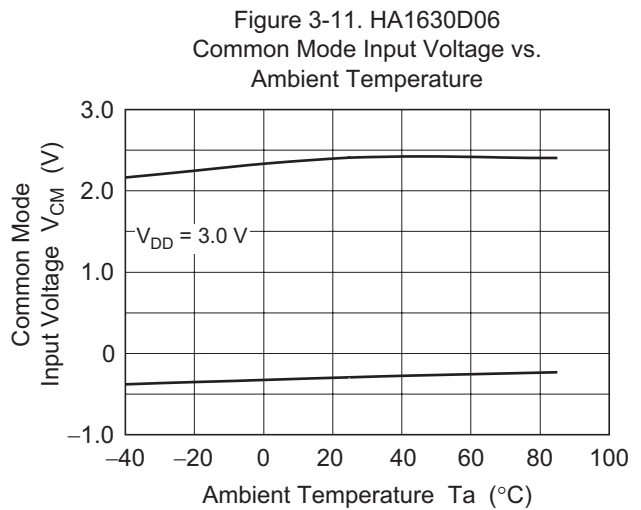
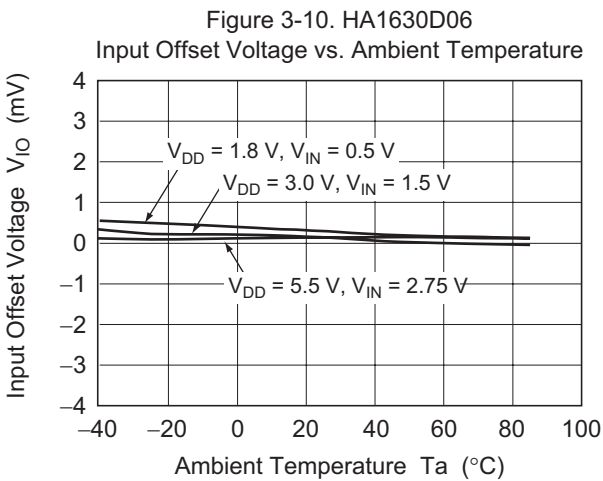
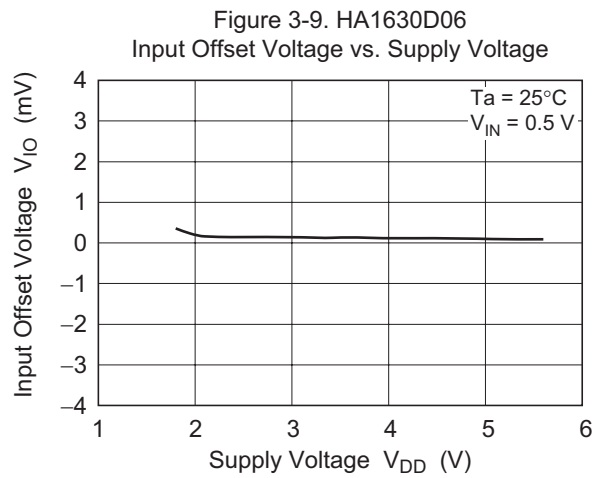
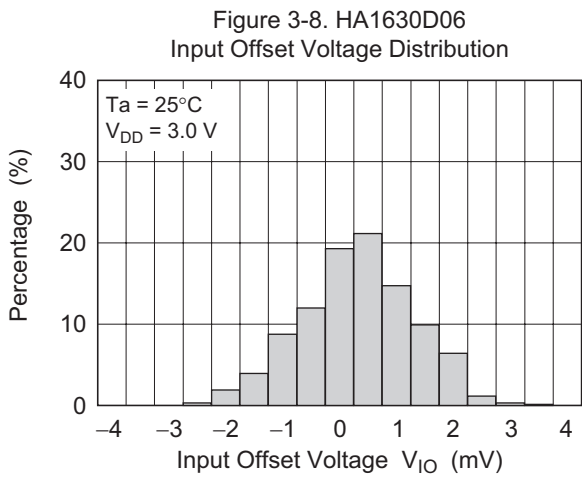
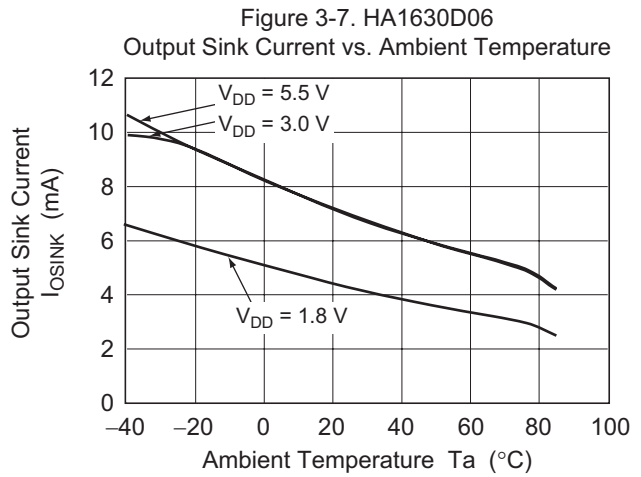
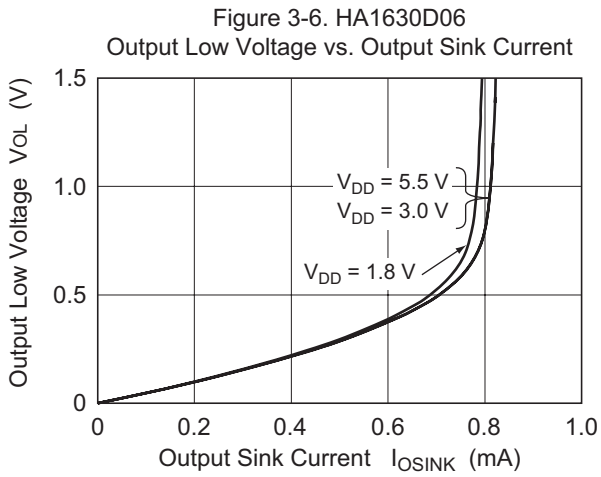



Figure 3-12. HA1630D06  
Power Supply Rejection Ratio vs. Frequency

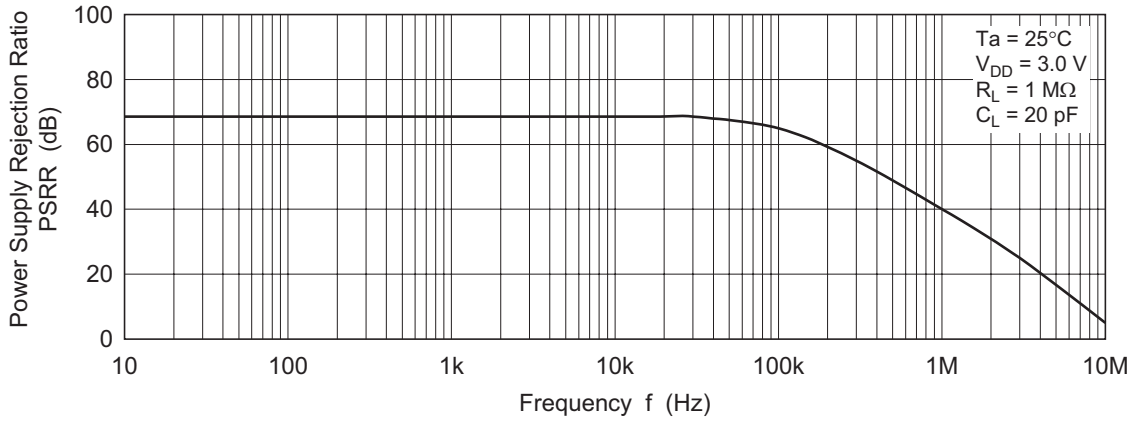

Figure 3-13. HA1630D06  
Common Mode Rejection Ratio vs. Frequency

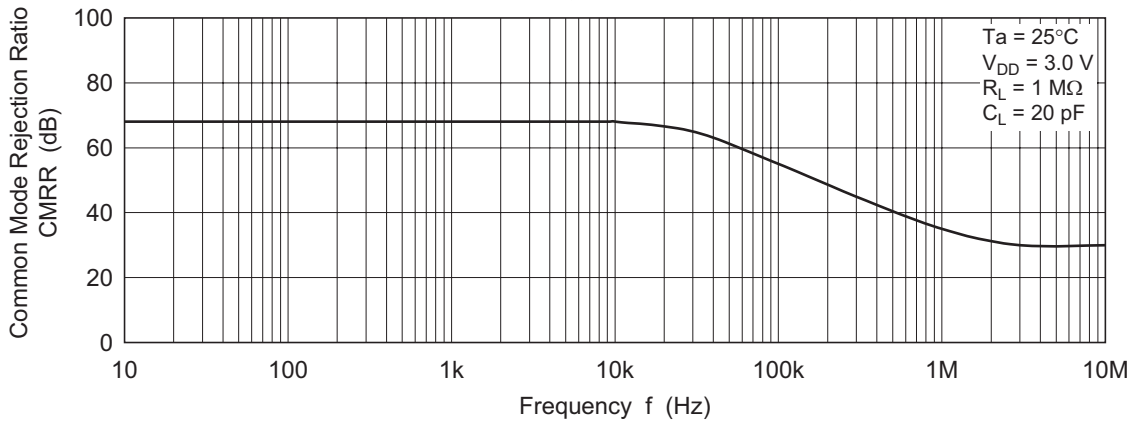
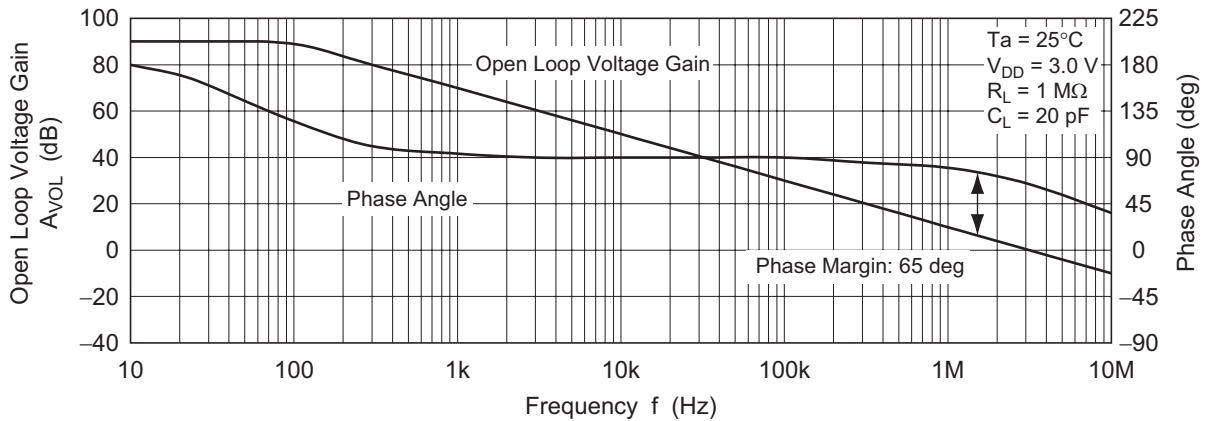

Figure 3-14. HA1630D06  
Open Loop Voltage Gain and Phase Angle vs. Frequency



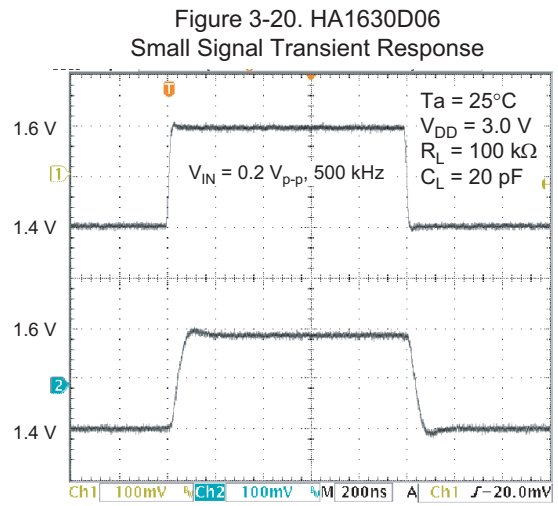
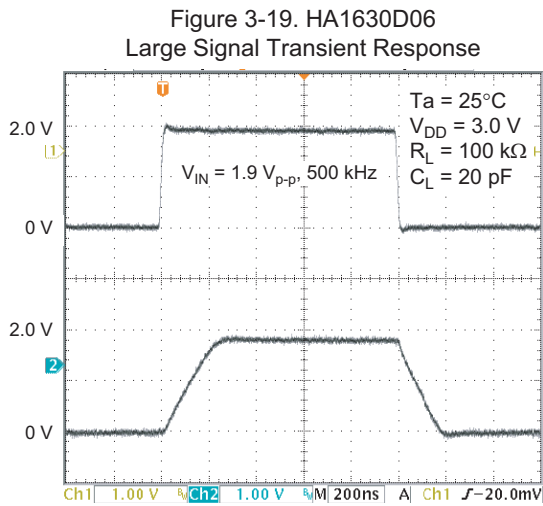
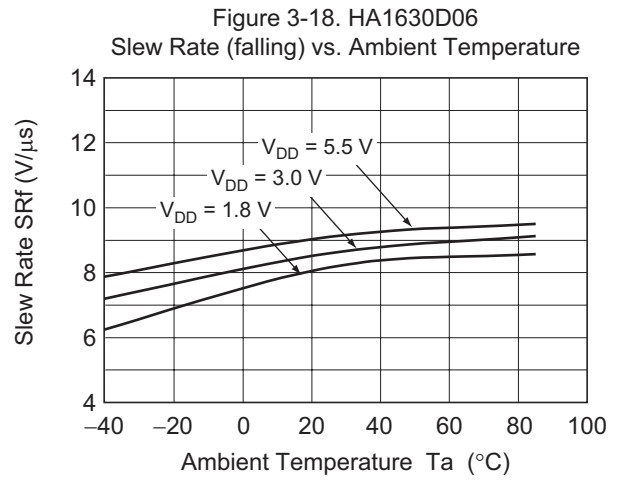
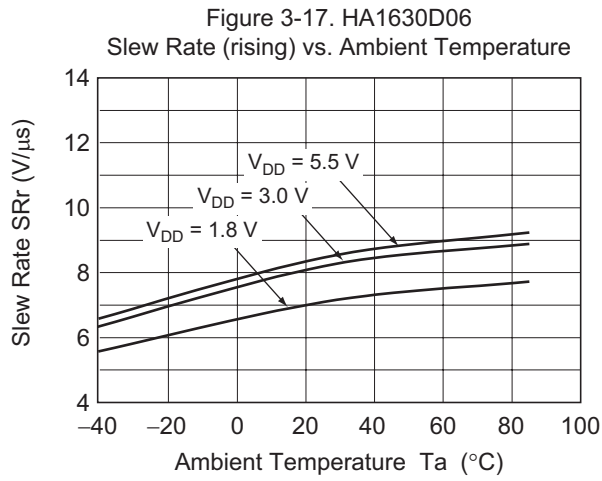
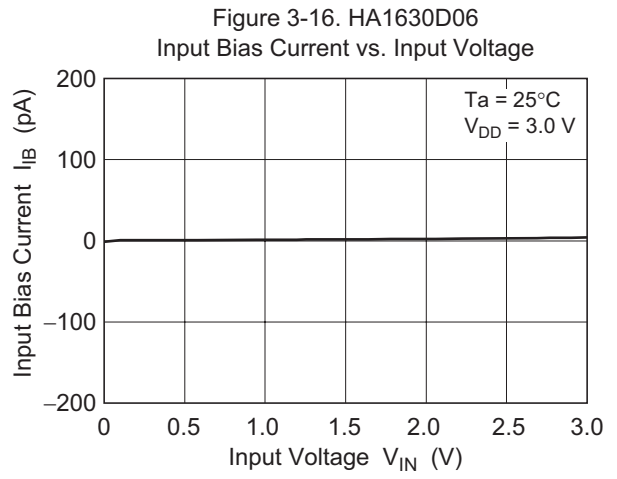
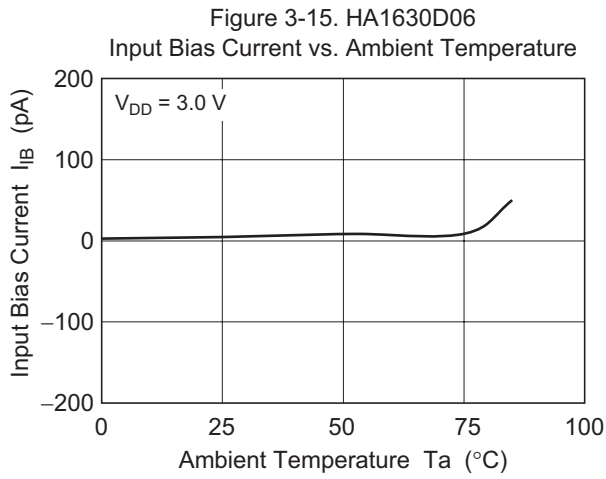

Figure 3-21. HA1630D06  
Total Harmonic Distortion + Noise vs.  
Output Voltage p-p

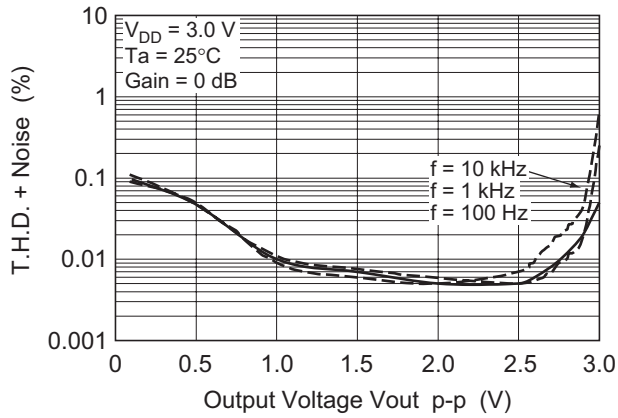

Figure 3-22. HA1630D06  
Total Harmonic Distortion + Noise vs.  
Output Voltage p-p

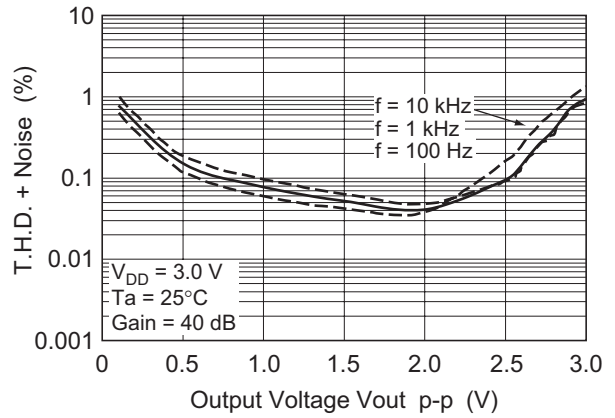

Figure 3-23. HA1630D06  
Voltage Output p-p vs. Frequency

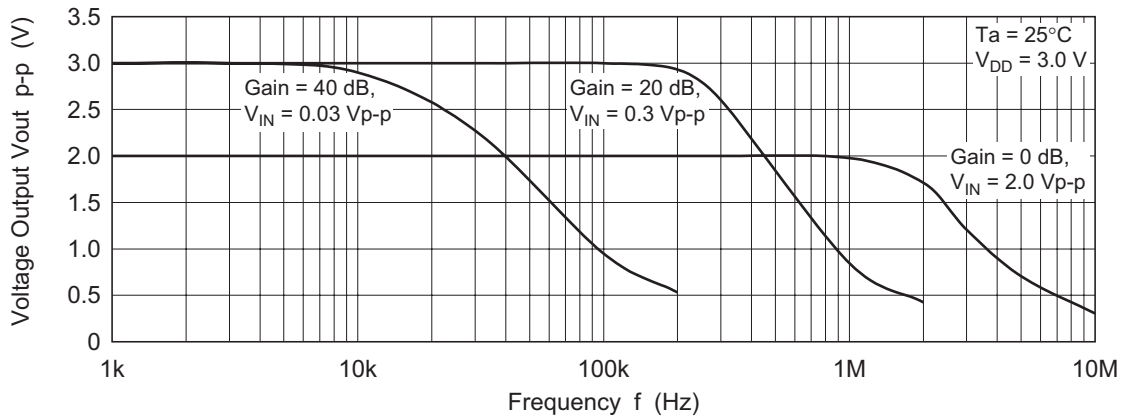

Figure 3-24. HA1630D06  
Voltage Noise Density vs. Frequency

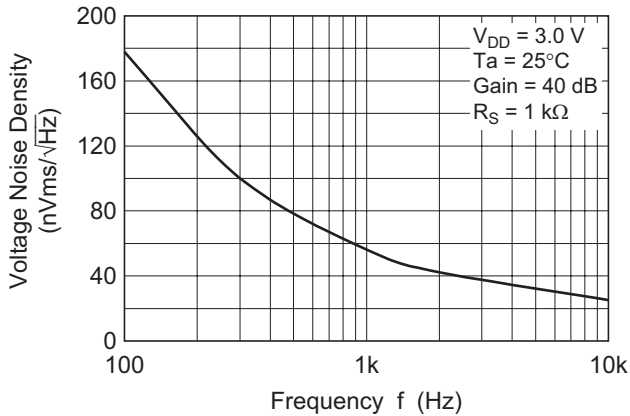
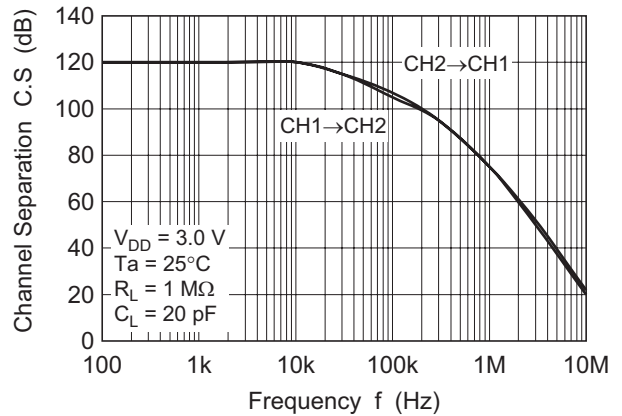
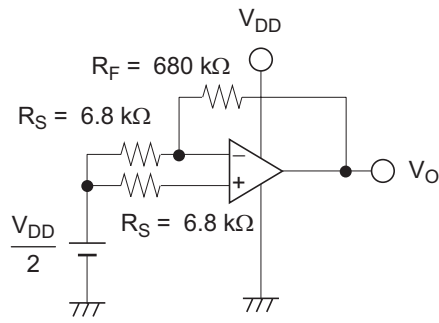

Figure 3-25. HA1630D06  
Channel Separation vs. Frequency



Test Circuits

1. Power Supply Rejection Ratio, PSRR & Voltage Offset,  $V_{IO}$



$$V_{IO} = \left( V_O - \frac{V_{DD}}{2} \right) \times \frac{R_S}{R_S + R_F}$$

PSRR

$$PSRR = -20 \log \left( \left| \frac{V_{DD1} - V_{DD2}}{V_{O1} - V_{O2}} \right| \times \frac{R_S}{R_S + R_F} \right)$$

Measure  $V_O$  corresponding to  $V_{DD1} = 2.95 \text{ V}$  and  $V_{DD2} = 3.05 \text{ V}$

2. Supply Current,  $I_{DD}$

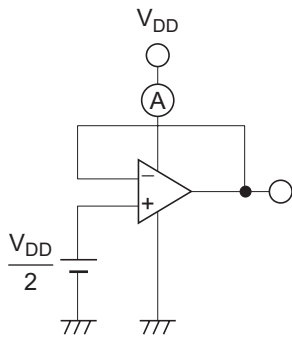

3. Input Bias Current,  $I_B$

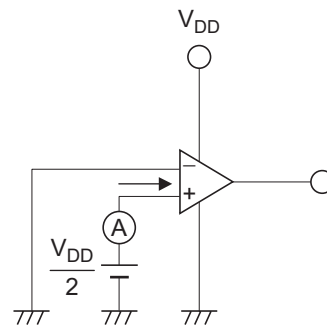

4. Output High Voltage,  $V_{OH}$

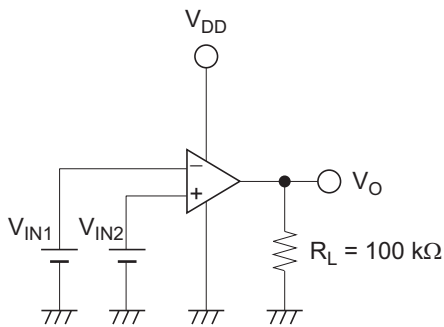

$$\begin{aligned} V_{OH} \\ V_{IN1} &= V_{DD} / 2 - 0.05 \text{ V} \\ V_{IN2} &= V_{DD} / 2 + 0.05 \text{ V} \end{aligned}$$

5. Output Low Voltage,  $V_{OL}$

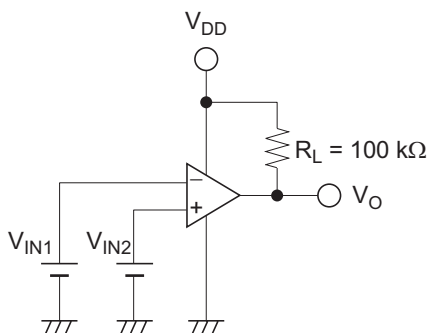

$$\begin{aligned} V_{OL} \\ V_{IN1} &= V_{DD} / 2 + 0.05 \text{ V} \\ V_{IN2} &= V_{DD} / 2 - 0.05 \text{ V} \end{aligned}$$

6. Output Source Current,  $I_{OSOURCE}$  & Output Sink Current,  $I_{OSINK}$

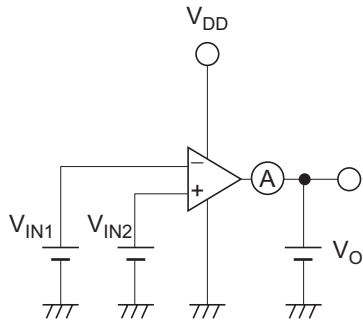

$I_{OSOURCE}$

$$V_O = V_{DD} - 0.5 \text{ V}$$

$$V_{IN1} = V_{DD} / 2 - 0.05 \text{ V}$$

$$V_{IN2} = V_{DD} / 2 + 0.05 \text{ V}$$

$I_{OSINK}$

$$V_O = + 0.5 \text{ V}$$

$$V_{IN1} = V_{DD} / 2 + 0.05 \text{ V}$$

$$V_{IN2} = V_{DD} / 2 - 0.05 \text{ V}$$

7. Common Mode Input Voltage,  $V_{CM}$  & Common Mode Rejection Ratio, CMRR

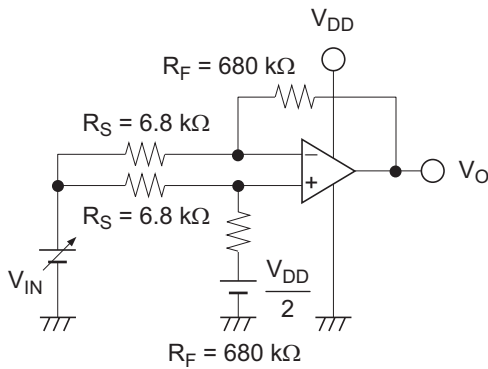

CMRR

$$CMRR = -20 \log \left( \left| \frac{V_{IN1} - V_{IN2}}{V_{O1} - V_{O2}} \right| \times \frac{R_S}{R_S + R_F} \right)$$

Measure  $V_O$  corresponding to  $V_{IN1} = 1.45 \text{ V}$  and  $V_{IN2} = 1.55 \text{ V}$

8. Total Harmonic Distortion, THD

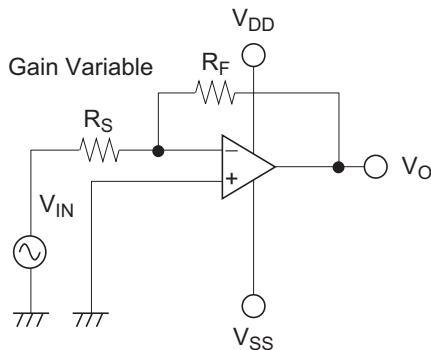

THD

Gain Variable  
 $R_F / R_S = 20 \log (100 \text{ k}\Omega / 1 \text{ k}\Omega) = 40 \text{ dB}$   
 $R_F / R_S = 20 \log (100 \text{ k}\Omega / 100 \text{ k}\Omega) = 0 \text{ dB}$   
 freq = 100 Hz, 1 kHz, 10 kHz  
 30 kHz LPF ON

9. Slew Rate, SR

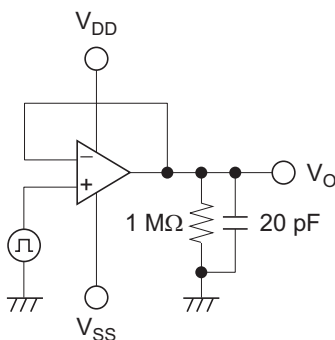

10. Gain,  $A_V$  & Phase, GBW

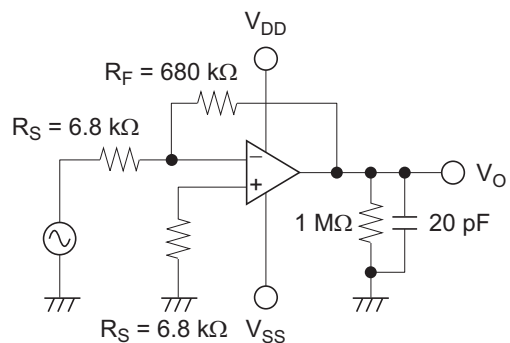

### Package Dimensions

JEITA Package Code	RENESAS Code	Previous Code	MASS[Typ.]
P-TSSOP8-4.4x3-0.65	PTSP0008JC-B	TTP-8DAV	0.034g

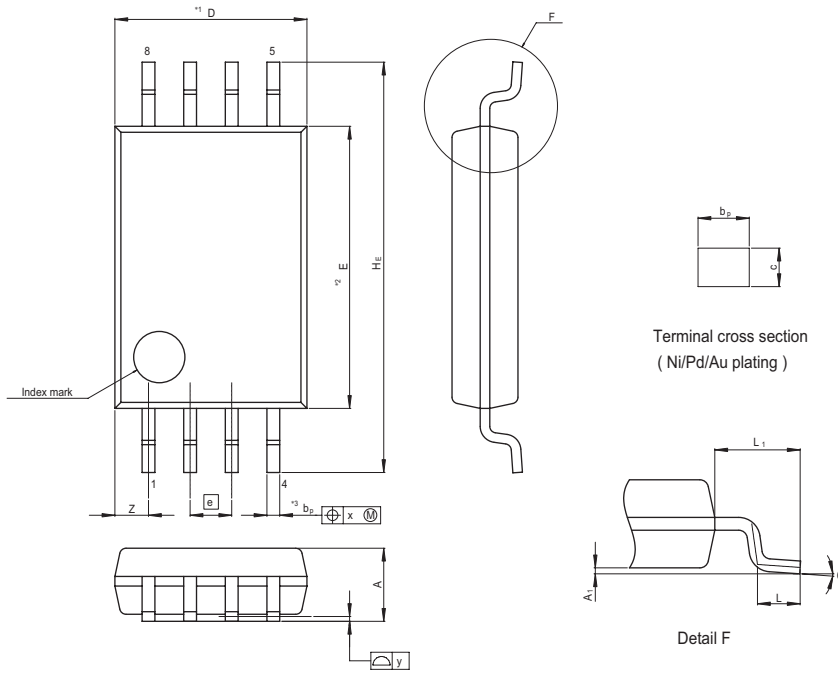

NOTE)  
 1. DIMENSIONS\*\*1 (Nom)\*\*AND\*\*2\*  
 DO NOT INCLUDE MOLD FLASH.  
 2. DIMENSION\*\*3\*DOES NOT  
 INCLUDE TRIM OFFSET.



Terminal cross section  
( Ni/Pd/Au plating )

Reference Symbol	Dimension in Millimeters		
	Min	Nom	Max
D	—	3.00	3.30
E	—	4.40	—
A <sub>2</sub>	—	—	—
A <sub>1</sub>	0.03	0.07	0.10
A	—	—	1.10
b <sub>P</sub>	0.15	0.20	0.25
b <sub>1</sub>	—	—	—
c	0.10	0.15	0.20
c <sub>1</sub>	—	—	—
θ	0°	—	8°
H <sub>E</sub>	6.20	6.40	6.60
e	—	0.65	—
x	—	—	0.13
y	—	—	0.10
Z	—	—	0.805
L	0.40	0.50	0.60
L <sub>1</sub>	—	1.00	—

Package Name	JEITA Package Code	RENESAS Code	Previous Code	MASS[Typ.]
MMPAK-8	P-LSOP8-2.8 x 2.95 - 0.65	PLSP0008JC-A	—	0.02 g

Unit: mm

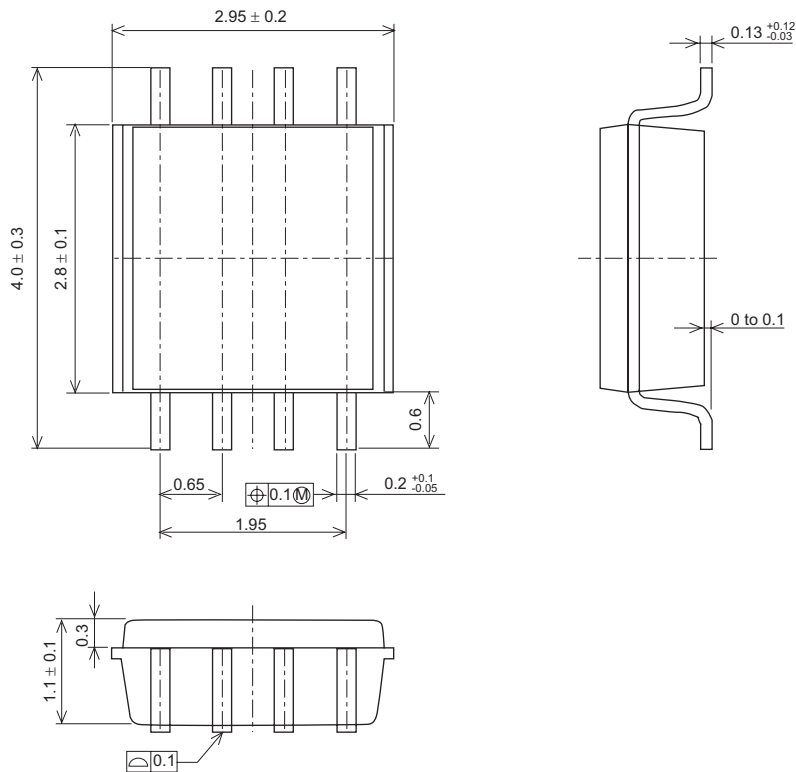

### Taping & Reel Specification

[Taping]

Package Code	W	P	A <sub>0</sub>	B <sub>0</sub>	K <sub>0</sub>	E	F	D <sub>1</sub>	Maximum Storage No.
TSSOP-8	12	8	6.9	3.6	1.7	1.75	5.5	1.5	3,000 pcs/reel
MMPAK-8	12	4.0	3.15	4.35	—	—	5.5	1.05	3,000 pcs/reel

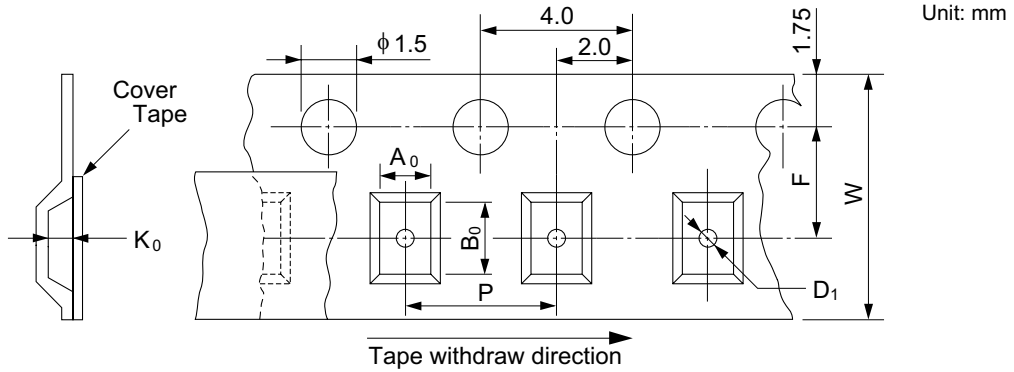

[Reel]

Package	Tape width	W1	W2	A
TSSOP-8	12	17.4	13.4	330
MMPAK-8	12	17.0	13.0	178

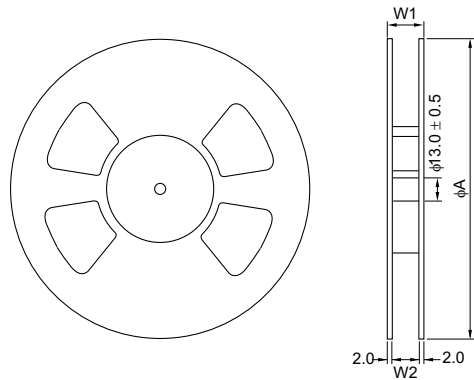

[Ordering Information]

Ordering Unit
3,000 pcs

### Mark Indication

TSSOP-8

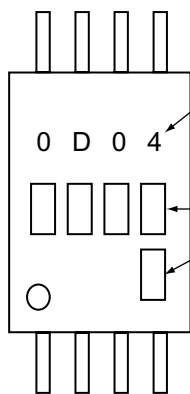

Product Name  
 0D04: HA1630D04  
 0D05: HA1630D05  
 0D06: HA1630D06

Trace Code

MMPAK-8

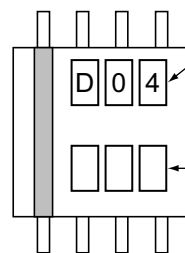

Product Name  
 D04: HA1630D04  
 D05: HA1630D05  
 D06: HA1630D06

Trace Code

Notes:

1. This document is provided for reference purposes only so that Renesas customers may select the appropriate Renesas products for their use. Renesas neither makes warranties or representations with respect to the accuracy or completeness of the information contained in this document nor grants any license to any intellectual property rights or any other rights of Renesas or any third party with respect to the information in this document.
2. Renesas shall have no liability for damages or infringement of any intellectual property or other rights arising out of the use of any information in this document, including, but not limited to, product data, diagrams, charts, programs, algorithms, and application circuit examples.
3. You should not use the products or the technology described in this document for the purpose of military applications such as the development of weapons of mass destruction or for the purpose of any other military use. When exporting the products or technology described herein, you should follow the applicable export control laws and regulations, and procedures required by such laws and regulations.
4. All information included in this document such as product data, diagrams, charts, programs, algorithms, and application circuit examples, is current as of the date this document is issued. Such information, however, is subject to change without any prior notice. Before purchasing or using any Renesas products listed in this document, please confirm the latest product information with a Renesas sales office. Also, please pay regular and careful attention to additional and different information to be disclosed by Renesas such as that disclosed through our website. (<http://www.renesas.com>)
5. Renesas has used reasonable care in compiling the information included in this document, but Renesas assumes no liability whatsoever for any damages incurred as a result of errors or omissions in the information included in this document.
6. When using or otherwise relying on the information in this document, you should evaluate the information in light of the total system before deciding about the applicability of such information to the intended application. Renesas makes no representations, warranties or guaranties regarding the suitability of its products for any particular application and specifically disclaims any liability arising out of the application and use of the information in this document or Renesas products.
7. With the exception of products specified by Renesas as suitable for automobile applications, Renesas products are not designed, manufactured or tested for applications or otherwise in systems the failure or malfunction of which may cause a direct threat to human life or create a risk of human injury or which require especially high quality and reliability such as safety systems, or equipment or systems for transportation and traffic, healthcare, combustion control, aerospace and aeronautics, nuclear power, or undersea communication transmission. If you are considering the use of our products for such purposes, please contact a Renesas sales office beforehand. Renesas shall have no liability for damages arising out of the uses set forth above.
8. Notwithstanding the preceding paragraph, you should not use Renesas products for the purposes listed below:
  - (1) artificial life support devices or systems
  - (2) surgical implantations
  - (3) healthcare intervention (e.g., excision, administration of medication, etc.)
  - (4) any other purposes that pose a direct threat to human lifeRenesas shall have no liability for damages arising out of the uses set forth in the above and purchasers who elect to use Renesas products in any of the foregoing applications shall indemnify and hold harmless Renesas Technology Corp., its affiliated companies and their officers, directors, and employees against any and all damages arising out of such applications.
9. You should use the products described herein within the range specified by Renesas, especially with respect to the maximum rating, operating supply voltage range, movement power voltage range, heat radiation characteristics, installation and other product characteristics. Renesas shall have no liability for malfunctions or damages arising out of the use of Renesas products beyond such specified ranges.
10. Although Renesas endeavors to improve the quality and reliability of its products, IC products have specific characteristics such as the occurrence of failure at a certain rate and malfunctions under certain use conditions. Please be sure to implement safety measures to guard against the possibility of physical injury, and injury or damage caused by fire in the event of the failure of a Renesas product, such as safety design for hardware and software including but not limited to redundancy, fire control and malfunction prevention, appropriate treatment for aging degradation or any other applicable measures. Among others, since the evaluation of microcomputer software alone is very difficult, please evaluate the safety of the final products or system manufactured by you.
11. In case Renesas products listed in this document are detached from the products to which the Renesas products are attached or affixed, the risk of accident such as swallowing by infants and small children is very high. You should implement safety measures so that Renesas products may not be easily detached from your products. Renesas shall have no liability for damages arising out of such detachment.
12. This document may not be reproduced or duplicated, in any form, in whole or in part, without prior written approval from Renesas.
13. Please contact a Renesas sales office if you have any questions regarding the information contained in this document, Renesas semiconductor products, or if you have any other inquiries.



**RENESAS SALES OFFICES**

<http://www.renesas.com>

Refer to "<http://www.renesas.com/en/network>" for the latest and detailed information.

**Renesas Technology America, Inc.**

450 Holger Way, San Jose, CA 95134-1368, U.S.A  
Tel: <1> (408) 382-7500, Fax: <1> (408) 382-7501

**Renesas Technology Europe Limited**

Dukes Meadow, Millboard Road, Bourne End, Buckinghamshire, SL8 5FH, U.K.  
Tel: <44> (1628) 585-100, Fax: <44> (1628) 585-900

**Renesas Technology (Shanghai) Co., Ltd.**

Unit 204, 205, AZIACenter, No.1233 Lujiazui Ring Rd, Pudong District, Shanghai, China 200120  
Tel: <86> (21) 5877-1818, Fax: <86> (21) 6887-7898

**Renesas Technology Hong Kong Ltd.**

7th Floor, North Tower, World Finance Centre, Harbour City, 1 Canton Road, Tsimshatsui, Kowloon, Hong Kong  
Tel: <852> 2265-6688, Fax: <852> 2730-6071

**Renesas Technology Taiwan Co., Ltd.**

10th Floor, No.99, Fushing North Road, Taipei, Taiwan  
Tel: <886> (2) 2715-2888, Fax: <886> (2) 2713-2999

**Renesas Technology Singapore Pte. Ltd.**

1 Harbour Front Avenue, #06-10, Keppel Bay Tower, Singapore 098632  
Tel: <65> 6213-0200, Fax: <65> 6278-8001

**Renesas Technology Korea Co., Ltd.**

Kukje Center Bldg. 18th Fl., 191, 2-ka, Hangang-ro, Yongsan-ku, Seoul 140-702, Korea  
Tel: <82> (2) 796-3115, Fax: <82> (2) 796-2145

**Renesas Technology Malaysia Sdn. Bhd**

Unit 906, Block B, Menara Amcorp, Amcorp Trade Centre, No.18, Jalan Persiaran Barat, 46050 Petaling Jaya, Selangor Darul Ehsan, Malaysia  
Tel: <603> 7955-9390, Fax: <603> 7955-9510